

The ProVia logo features a stylized white leaf icon to the left of the brand name "ProVia" in a bold, sans-serif font. Below the brand name, the tagline "THE PROFESSIONAL WAY" is written in a smaller, all-caps, sans-serif font.

**ProVia**  
THE PROFESSIONAL WAY

ENTRY DOORS

A close-up photograph of a dark-stained wood-grain entry door. The door features a large, multi-paned window with a decorative leaded-glass pattern. A black handle and lock assembly are mounted on the right side of the door. The background shows a blurred green lawn and trees.

# ENTRY DOORS

# NEW FOR 2024

We rely on our trusted building professionals, contractors, and homeowners, in partnership with our experienced door product team, for input on exterior design trends. We're excited to introduce new options which elevate the integrity, function and beauty of our entry doors.

## DOOR STYLES

Shown on pgs. 13-20

Signet<sup>®</sup>, Heritage<sup>™</sup> + Legacy<sup>™</sup> Smooth

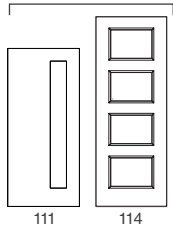

Legacy Smooth

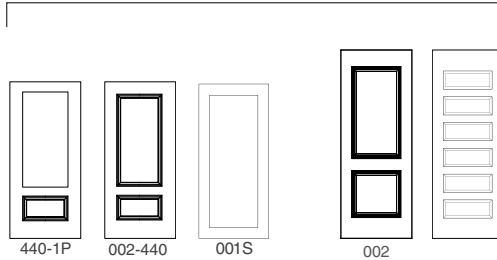

Signet Smooth

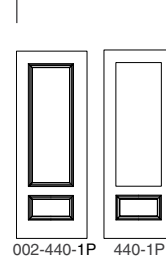

## SMOOTH SIMULATED DIVIDED PANELS

More styles available on pg. 31

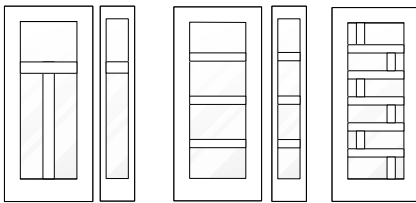

## GLASS

Genesis shown on pg. 61. Art glass shown on pgs. 83-84

DECORATIVE



GENESIS

ART



IMPERIAL



PALM



POPPY

## BLACK INTERNAL BLINDS

Shown on pg. 38



## RANGER<sup>®</sup> PET DOORS

Shown on pg. 115



ProVia is excited to introduce new stain and paint colors for 2024 that align with industry and home exterior design trends.

## STAINS

Shown on pgs. 85-87

### Cherry & Mahogany Stains (Shown on Cherry)

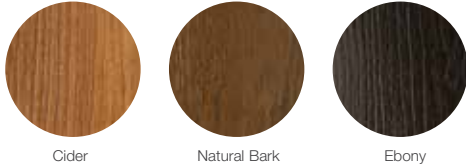

Cider

Natural Bark

Ebony

### Oak, Knotty Alder & Fir Stains (Shown on Oak)

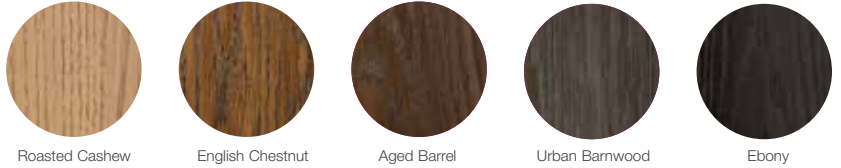

Roasted Cashew

English Chestnut

Aged Barrel

Urban Barnwood

Ebony

### Glazed Finishes (Shown on Oak)



Driftwood

Weathered Juniper

## PAINTS

Shown on pg. 89

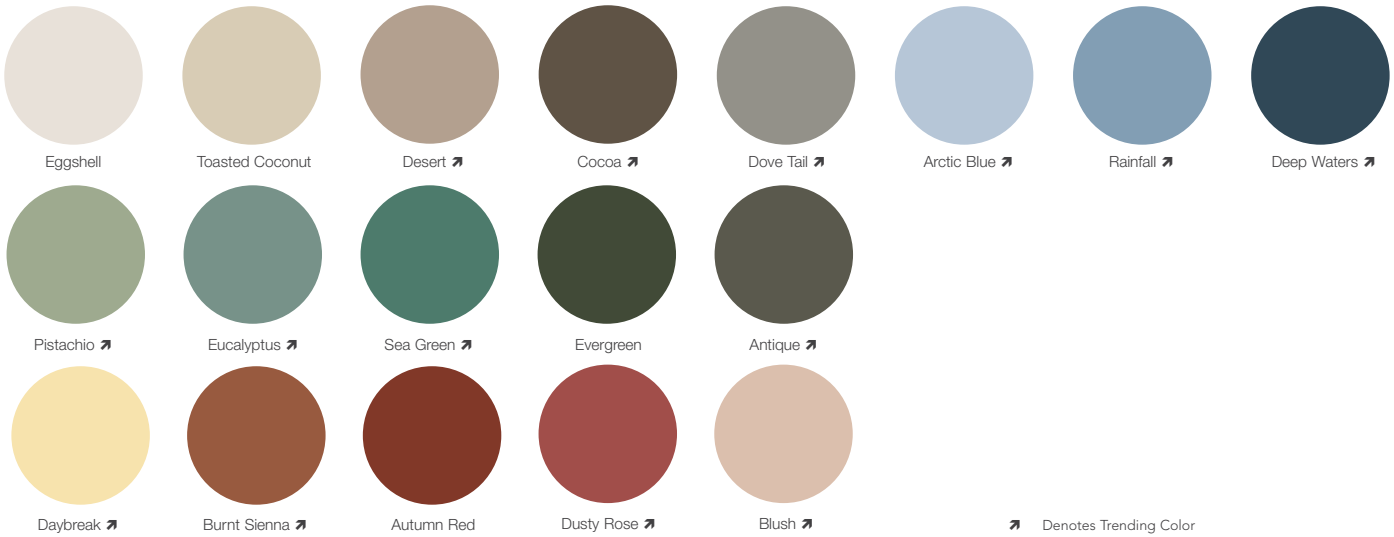

Eggshell

Toasted Coconut

Desert

Cocoa

Dove Tail

Arctic Blue

Rainfall

Deep Waters

Pistachio

Eucalyptus

Sea Green

Evergreen

Antique

Daybreak

Burnt Sienna

Autumn Red

Dusty Rose

Blush

➤ Denotes Trending Color

## HARDWARE

Emtek® shown on pgs. 105-106

Schlage® shown on pg. 109

### EMTEK



### EMTEK DOOR PULLS

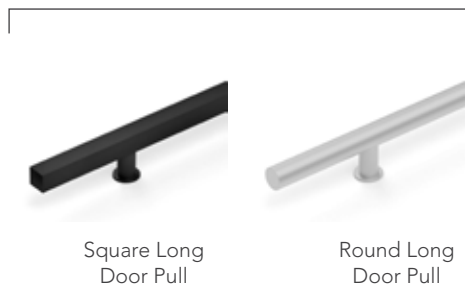

Square Long Door Pull

Round Long Door Pull

### SCHLAGE



# PROVIA® BUILDS DOORS THE PROFESSIONAL WAY

---

ProVia caters to a niche within the door market that demands a high degree of customization coupled with outstanding quality. Our company defines the products that meet this demand as “professional-class.” We have found success by adhering to a set of core values that guide us as we develop rewarding, long-term relationships with our employees, customers and homeowners.

## WHAT MAKES PROVIA PROFESSIONAL-CLASS?

---

### ENTRY SYSTEMS **TAILORED** FOR YOUR HOME

Today’s off-the-rack doors, which are mass-produced and not customized for your home, often fall short of expectations and performance.

These shortcomings are the driving force behind ProVia’s custom entry doors, built to your home’s exact measurements for a precise fit, protection, security, and energy efficiency. The materials that go into our custom-made doors are premium quality and exceptionally durable, far surpassing the ready-made doors at the big-box hardware stores, and our craftsmanship and care for details can be seen in each door we produce.



**SECURITY** | We ensure the strength and security of every door, so you have peace of mind and can focus on what’s really important - your life.



**DURABILITY** | Crafted with the finest materials and backed by our Lifetime Limited Transferable Warranty, the durability of our products can’t be beat.



**BEAUTY** | A beautiful ProVia entry system will always greet your guests with classic elegance and style.



**ENERGY EFFICIENCY** | Engineered to keep the elements at bay and your home comfortable all year long.





## INDUSTRY ASSOCIATION

ProVia is a proud member of the Window and Door Manufacturers Association (WDMA) and American Architectural Manufacturers Association (AAMA) - leading voices in our industry. As such, we support advocacy in building code and ASTM standard arenas, quality materials, installation and design in doors and windows.

## ENTRY DOORS

Components.....	5-8
Embarq® Fiberglass Features.....	9-12
Signet® Fiberglass Features .....	13
Heritage™ Fiberglass Features .....	15
Legacy™ Steel Features .....	17
8' Doors.....	19
Door Features.....	21
French Doors.....	23
Inscribed Doors.....	24
Clear Glass.....	25
ComforTech™ .....	27
Simulated Divided Lites .....	29
Simulated Divided Panels .....	31
Internal Grids.....	33
External Grids.....	36
White Internal Blinds .....	37
Colored Internal Blinds.....	38
Privacy Glass.....	39
Decorative Glass .....	41
Brookhaven.....	43
Carlisle.....	45
Carrington.....	47
Constance.....	49
Eclipse.....	51
Esmond.....	53
Essence .....	55
Florence .....	57
Gemstone .....	59
Genesis.....	61
Laurence.....	63
Manhattan.....	65
Mirage.....	67
Somerset.....	69
Symphony .....	71
Tacoma.....	73
Tranquility.....	75
Barcelona .....	77
Carmen.....	79
Art Glass.....	81-84

## FINISHING TOUCHES

Stain Finishes.....	85-88
Paint Finishes.....	89
Hardware.....	93-112
Accessories .....	113
Pet Doors.....	115
Casing and Cladding.....	116

## PATIO DOORS

Hinged Patio Doors .....	117
--------------------------	-----

## STORM DOORS

Storm Doors .....	121
-------------------	-----

# ENHANCE YOUR CURB APPEAL

Professional-grade exterior products from ProVia® boost curb appeal and offer protection and security. Elevate the appearance and upgrade privacy and safety of your home with these entry door options and accessories.



## LET THE LIGHT SHINE IN

Shield your front door from extreme weather and welcome more natural light in your home with a stylish storm door. Durable, attractive storm doors from ProVia provide protection, prevent drafts, and infuse your entryway with abundant sunlight



Create an elegant entryway with ProVia beveled glass. Cut and polished glass, intricate etched designs, and brass or zinc inlays combine for a multifaceted, magnificent doorway.



# CUSTOM COLORS

ProVia offers a diverse collection of attractive entry door paint colors, but for homeowners who want to showcase their personal aesthetic, custom color matching is the perfect option. Provide your dealer with your favorite paint swatch, and we'll deliver a beautifully finished door that matches your style.

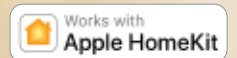

# SMART HOME TECH

## SCHLAGE ENCODE PLUS™ SMART WIFI DEADBOLT

Arm your entryway with a durable ProVia door equipped with Schlage Encode Plus Smart WiFi Deadbolt. Convenient home access, control, security, and peace of mind, all in the palm of your hand.



# THE COMPONENTS

The components are the small things that set our doors apart from the competition. A lot of small things add up to a big difference.



440TAC-2P, 140TAC



- A** Your home is unique and deserves to have **custom glass options** like our ComforTech™ Warm Edge Glazing Systems which include decorative glass, art glass, internal blinds and internal and external grids in many grid patterns and colors.

 Impact Shield doors feature laminated glass.



- B** Our **2½" casing** conveniently covers paint lines providing a professional installation. **Also available in 3½"**. Choose from Cherry, Mahogany, Oak and Poplar. Flat Fir and Poplar trim are available in paint, stain and glazed finishes.



- C** Glass trim is available in different textures and styles to best complement each door with glass. Trim options will be determined based on the door style chosen. All glass trim falls into one of two main categories: Flat and Contoured.





**D** The **Z-AC™ threshold** has an auto-adjusting riser and built-in sealing system that redefines how your door can perform for you. Standard on Embarq, Signet and Legacy.

- **Automatically adjusts** to your entry door's changing needs over time, eliminating service calls
- Delivers **protection** against air and water infiltration



**E** Three **heavy-duty ball bearing hinges** come standard with every entry system.

**Additional 4th hinge option** for greater durability. (only available with FrameSaver®)

*A 4th hinge is standard on 8 ft. doors.*



**H** The **dust box** in the deadbolt strike provides a barrier to air infiltration while providing a nice appearance that most other door manufacturers don't provide.



**F** The energy-efficient **weatherstripping** runs along the top and sides of the door and interlocks with the CornerShield™ for the most efficient seal you'll find for keeping moisture, wind and dirt out of your home.

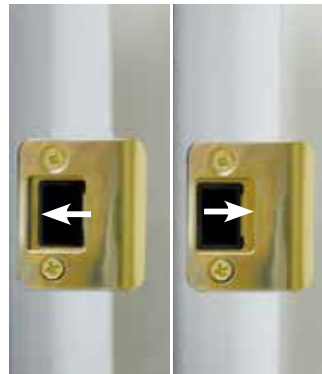

**H** An exclusively designed **fully adjustable strike plate** is included. This unique 2-piece construction makes our doors easier to custom fit.



**G** We include our **20-gauge security plate** for extra strength and to help prevent kick-ins.



**I** **Bulb and dual blade sweep** virtually eliminates drafts, keeping your home comfortable.

# THE COMPONENTS

## FRAMES

### FrameSaver®

**FrameSaver wood frame and brickmold** with finger-jointed composite bottom prevents water absorption and carries a Lifetime Limited Warranty when used with **PVC vinyl coated aluminum frame cladding** outside.

**Also available with smooth cladding.**



### PermaTech™



Our **PermaTech™ Composite door frame system** option combines all the strength and convenience of wood with enhanced properties that make it moisture and insect resistant. PermaTech will not absorb or wick moisture and will never rot or splinter, and is covered by a Lifetime Limited Warranty.\*

\* No storm door applied. See full warranty for limitations.

### Steel L-Frame

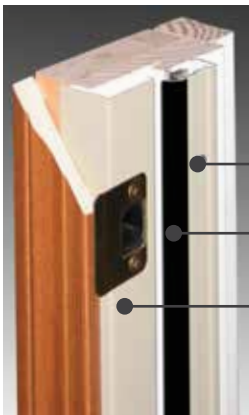

Available on select Signet and Legacy door styles

● Aluminum door stop provides greater security and is more durable than wood

● Energy efficient weatherstripping

● 18-gauge steel L-frame with a 12-gauge hinge plate welded on for extra strength and security

(NOT tested for Certified Wind Load or Impact Shield regions)

Not all Steel L-Frames are ENERGY STAR® certified.

# FusionFrame™

FusionFrame: A one-of-a-kind alternative to composite or wood jambs, this component utilizes the strength of an LVL interior, the rot-proof performance of a FrameSaver® bottom, and the durability of a composite frame exterior. Offering a lifetime jamb warranty\*.

## PREFINISHED, MAINTENANCE-FREE

Available as a textured or smooth frame, providing you with the benefit of a prefinished, maintenance-free system, along with the beauty of a stain or paint finish that matches your entry door.

*Not available for outswing doors. See entryLINK for complete limitations and restrictions.*

*\*Finish warranty will match the finish warranty of door series*

## Standard Brickmold (Smooth)



*All FusionFrame options are available in textured or smooth.*



## 3½" Flat Rippable Brickmold (Textured)



### FLOATING BRICKMOLD

Even if your walls aren't plumb, your door unit can be. With ¼" of "float," the floating brickmold adjusts to fit your needs. Remove covers, install fasteners and reattach covers for a flawless, clean install.



### INSTALLATION HOLES

Pre-drilled holes in frame for ease of installation.



### COMPOSITE BOTTOM

Prevents water absorption, warping and rotting.



### PLUMB INDICATOR

Removable frame stop cover allows for concealed plumb indicator and fasteners.

- Installation made easy
- Removable frame and brickmold covers
- Eliminates unsightly fastener holes



### ULTIMATE FLEXIBILITY

Get ultimate flexibility between 4<sup>9</sup>/<sub>16</sub>" and 8<sup>9</sup>/<sub>16</sub>" frame widths.

## ADDITIONAL OPTIONS

Mull Cover for 1" Build-Up

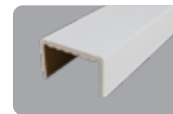

Transom Cover 4<sup>9</sup>/<sub>16</sub>" up to 6<sup>9</sup>/<sub>16</sub>" jambs

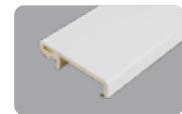

3½" \* Rippable Brickmold to 2" – Thickness of 1<sup>1</sup>/<sub>16</sub>"



*\*Ripping brickmold produces a rough-cut edge which will be painted or stained, but not exactly match the original textured or smooth finish.*



# EMBARQ® FIBERGLASS

## EXCEPTIONAL EFFICIENCY, ELEGANT AESTHETICS

The Embarq fiberglass entry door from ProVia® sets the standard for exceptional energy efficiency. The innovative design includes engineered channels in the side rails and header, and a polyurethane core with significantly more insulating value than a typical fiberglass door. This 2 1/2" thick robust entry door is not only highly durable – it's gorgeous as well, with the authentic look of rich, handsome wood.

## EMBARQ SKIN OPTIONS

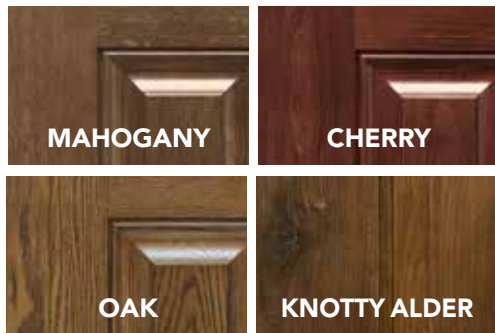

ALL Embarq Fiberglass Entry Systems are ENERGY STAR® Certified.

### 15-YEAR FINISH WARRANTY\*

See pgs. 85-89 for paint and stain finishes.



## EMBARQ FIBERGLASS DOOR STYLES

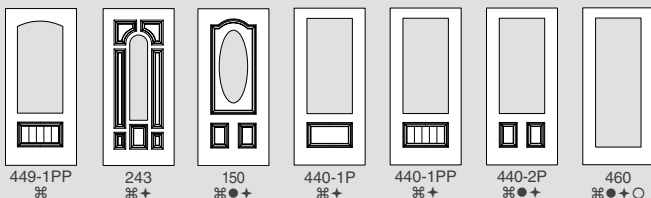
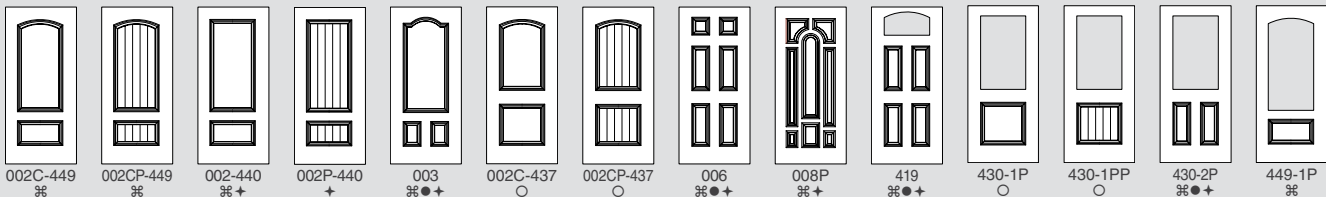

### SIDELITES

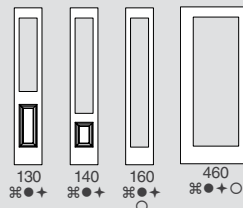

- ⌘ Embarq® Cherry
- Embarq® Mahogany
- + Embarq® Oak
- Embarq® Knotty Alder

\*Warranty time period may be limited in extreme applications. See warranty for details.

Stiles and rails are dovetailed and glued at each corner creating a structurally solid, integrated frame.



We engineered a channel in the side rails and header of the door to allow for a **larger energy-efficient polyurethane core**. Our computer-controlled process fills every crevice with the foam barrier material resulting in **a level of energy efficiency unparalleled in the industry**.

We started from the inside out to maximize energy savings and reduce thermal loss, resulting in the most energy-efficient door in the U.S. market. In fact, this door offers **significantly more insulating value than a typical fiberglass entry door**, giving an unprecedented U-Factor of up to 0.10 - the lowest recorded heat conduction measurement for entry doors in the U.S.

**The authentic wood look** is made possible by using cutting-edge **NVD** (Nickel Vapor Deposition) technology by MasterGrain™.

**Scientifically formulated compounds** provide superior resistance to denting, splitting, cracking and warping.

To enhance efficiency and accommodate more insulation, we thickened the door and sidelites from the standard 1 1/4" to 2 1/2" which is **43% thicker** than standard exterior doors. We also engineered a **dual-perimeter seal** for the entry door to create a superior barrier against drafts and energy leaks.

**Door edge** is constructed with Cherry, Mahogany or Oak wood matching the selected series.

The **4 1/4" finger-jointed 4-ply hardwood strike stile** provides a solid mounting surface for Emtek® hardware and superior structural integrity.

The revolutionary **DuraFuse™ Finishing System featuring P³ Fusion** yields unprecedented finish durability.

**A custom-designed sweep** accommodates the Embarq door's added thickness. This creates a new breed of thermal barrier to keep out unwanted elements and uncomfortable temperatures.

**Z-AC Threshold with auto-adjusting riser**. Standard with anodized bronze finish.

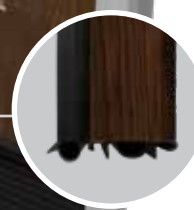

# EMBARQ® FIBERGLASS

## QUAD GLASS SYSTEM

For an entry door as uncompromising as Embarq, only the most energy efficient glass package will do. The Quad Glass System utilizes a 1<sup>3</sup>/<sub>16</sub>" insulated unit with two panes of low-e glass and warm-edge spacers. Available only with Embarq fiberglass doors and sidelites, the system provides optimal energy efficiency.

- A** Low-E Glass Surface
- B** Krypton Filled Air Space
- C** Argon Filled Air Space
- D** Decorative Glass Core (optional)
- E** Super Spacer®
- F** Barrier Sealant
- G** We re-engineered our ComforTech Warm Edge Glazing System to accommodate for the extra panes of glass in this highly efficient package.



QLK 1<sup>3</sup>/<sub>16</sub>"  
Insulated Glass Unit

## EMBARQ GLASS PACKAGES

ComforTech™ **QLK**  
(Krypton Gas Filled)



R-Value of 10

ComforTech™ **QLA**  
(Argon Gas Filled)



R-Value of 9

R-Value reflects properties of the glass only.  
Embarq glass package center of glass calculations.

## HARDWARE

Embarq doors are only available with Emtek® hardware pictured below. See pg. 99-104 for finish availability.

### EXTERIOR STYLES



### INTERIOR STYLES



Egg\*  
(Recommended on Melrose)

Cortina\*  
(Recommended on Orleans)

Egg\*  
(Recommended on Marietta)

Stuttgart  
(Only available on Davos)

Emtek Select  
(Only available on Urban Modern)

\* Only available on Melrose, Marietta and Orleans.



440 2P Embarq door shown in Dutch Gray glazed finish, Laurence Decorative Glass and sidelites with Chinchilla Privacy Glass with Emtex Melrose hardware in Satin Brass finish.

# SIGNET® FIBERGLASS

Signet Fiberglass doors are available in Mahogany, Cherry, Oak, Knotty Alder, Fir and Smooth Series. Structurally, the Signet door is far superior to traditional fiberglass doors with robust hardwood stiles and rails dovetailed at each corner. All Signet Fiberglass doors exhibit our exclusive DuraFuse™ Finishing System featuring P<sup>3</sup> Fusion, allowing us to offer an industry-best 15-year\* finish warranty.

## SIGNET SKIN OPTIONS



 **CUSTOM WIDTHS & HEIGHTS**  
Need a little more height or a little less width? We offer customized door and sidelite widths and heights in 1/8" increments.

 **CUSTOMIZE BOTH SIDES**  
You can customize your entry by ordering a different series, style and finish on each side of your door.

 Most Signet Fiberglass Entry Systems are ENERGY STAR® Certified.

**15-YEAR FINISH WARRANTY\***  
See pgs. 85-89 for paint and stain finishes.

## SIGNET FIBERGLASS DOOR STYLES

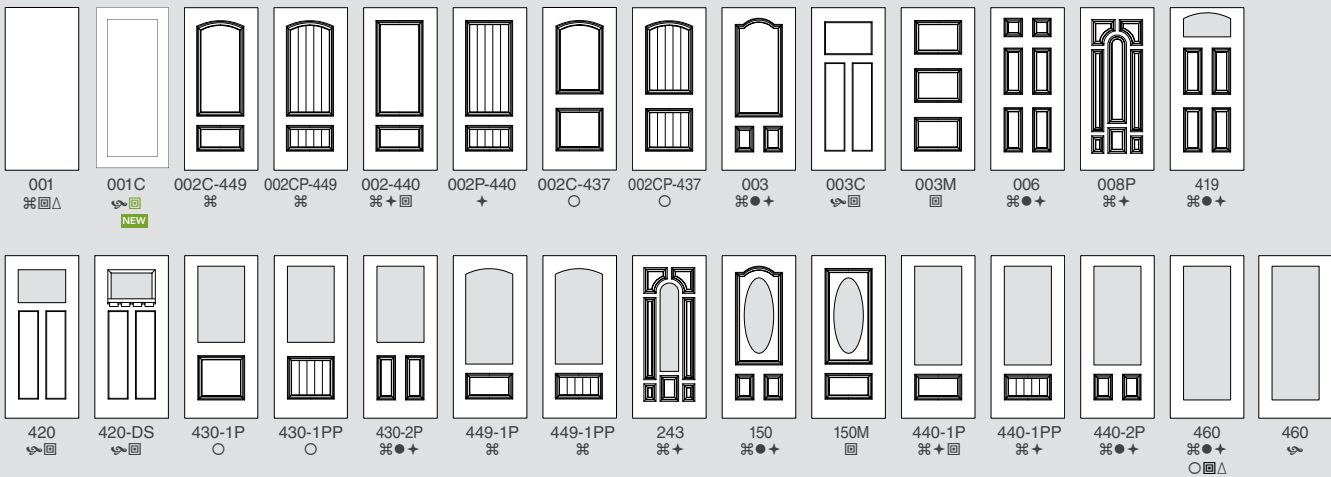

## SIDELITES

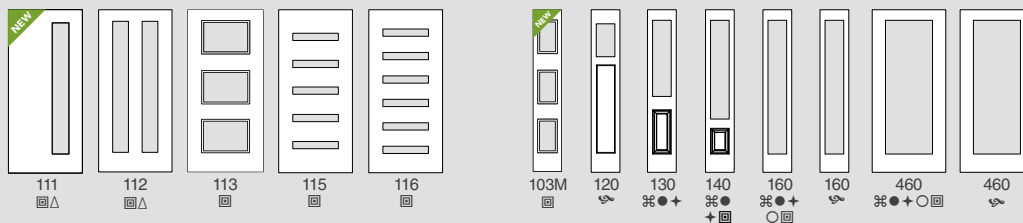

- ⌘ Signet Cherry
- Signet Mahogany
- + Signet Oak
- Signet Knotty Alder
- ☞ Signet Fir
- ◻ Signet Smooth
- △ Available in 30" Single or 60" French Doors

Entry System U-Factor: As low as .16 (Tested to NFRC specifications for a 6 panel door with wood frame).  
Note: All Signet doors are shipped finished.

\* Warranty time period may be limited in extreme applications. See warranty for details.  
† Patents - USD617005, USD621062, USD621063, USD625837, USD625024





The inside door **frame is hand-stained or painted to match your door** providing you with a consistent visual appearance. (Signet doors are also available with a Steel L-frame.)



**Stiles and rails are dovetailed** at each corner creating a structurally solid, integrated frame.



The **2 1/2" finger-jointed 3-ply hardwood hinge stile** provides superior structural integrity.

Glue is applied to the **rails and stiles** to permanently adhere the door skin to the frame.

Signet doors are **foam filled by a computer driven process** that ensures the optimal foam fill for maximum efficiency and strength.

**Door edge** is constructed with Cherry, Mahogany, Oak or Fir wood matching the selected series.

The **authentic wood look** is made possible by using cutting-edge **NVD** (Nickel Vapor Deposition) technology by MasterGrain™.



The **4 1/4" finger-jointed 4-ply hardwood strike stile** provides a solid mounting surface for decorative hardware and superior structural integrity.

**Scientifically formulated compounds** provide superior resistance to denting, splitting, cracking and warping.

**High-definition panel profile** creates excellent shadow lines and distinct panel designs.

The revolutionary **DuraFuse™ Finishing System featuring P<sup>3</sup> Fusion** yields unprecedented finish durability.

**Plugless Glass Trim** is standard on Signet.  
U.S. Patent: 9,562,389  
U.S. Patent: 9,976,338

**Z-AC Threshold with auto-adjusting riser.** Standard with anodized bronze finish.



A **high-performance, composite material** is used on all Signet fiberglass bottom rails, giving excellent rot-resistance.

# HERITAGE™ FIBERGLASS

Heritage Fiberglass doors feature enhanced woodgrain texture, improved definition embossing and a hardwood edge to prevent warping.

## HERITAGE SKIN OPTIONS

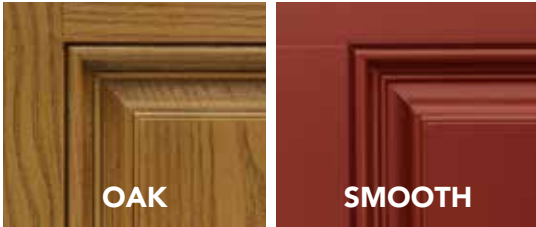

### CUSTOM HEIGHTS

Need a little more or a little less height? We offer customized door and sidelite heights in 1/8" increments.



Most Heritage Fiberglass Entry Systems are ENERGY STAR® Certified.

### 10-YEAR FINISH WARRANTY\*

See pgs. 85-89 for paint and stain finishes.

## HERITAGE FIBERGLASS DOOR STYLES

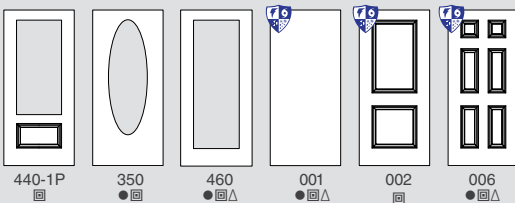
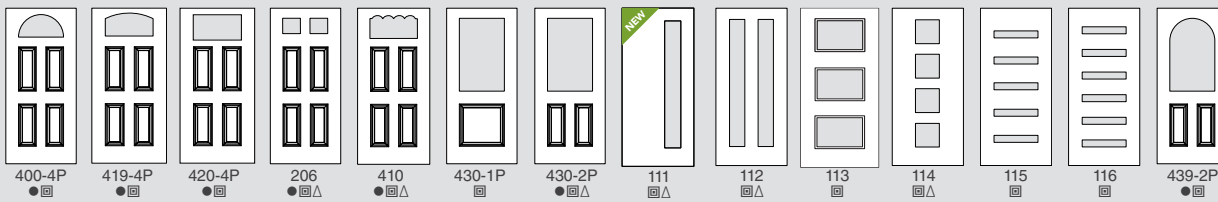

## SIDELITES

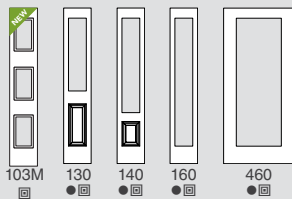

- Oak Grain
- Smooth Fiberglass
- △ Available in 30" Single or 60" French Doors

 Only Heritage Fiberglass doors without glass are available as an Impact Shield Product.

Entry System U-Factor: As low as .14 (Tested to NFRC specifications for a 6 panel door with wood frame).

\* Warranty time period may be limited in extreme applications. See warranty for details.



**Polyurethane core** reduces energy loss.

**Improved definition panel profile** creates excellent shadow lines and distinct panel designs.

**Specially engineered fiberglass door facings** will not dent and resist splitting, cracking and warping.

**Plugless Glass Trim** is optional on Heritage Fiberglass. (see entryLINK for available styles)

U.S. Patent: 9,562,389  
U.S. Patent: 9,976,338

**ZAI™ threshold** has a manually-adjustable riser with complementary screw cover caps. Standard with aluminum mill finish.

**1 1/8" Finger-jointed, 2-ply solid oak laminated stiles** for both hinge and strike sides are proven to provide increased rigidity and structural integrity.

**Variable-depth woodgrain texture with hand-applied stain** imitates a wood door appearance.

**Square-edge design** offers an attractive wood door appearance.

**Lock area is reinforced** to provide a solid mounting surface for decorative hardware.

**A high-performance, composite material** is used on all Heritage fiberglass bottom rails, giving excellent rot-resistance.

# LEGACY™ STEEL

Legacy Steel features add up to a professional-class product. Whether you select Legacy Woodgrain Textured Steel or Smooth Steel, our entry systems will provide an elegant, durable and energy efficient addition to any home.

## LEGACY SKIN OPTIONS

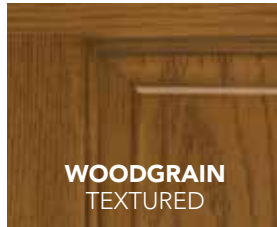
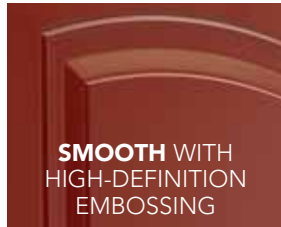

### CUSTOM WIDTHS & HEIGHTS

Need a little more height or a little less width? We offer customized door and sidelite widths and heights in 1/8" increments.



### CUSTOMIZE BOTH SIDES

You can customize your entry by ordering a different series, style and finish on each side of your door.



Most Legacy Steel Entry Systems are ENERGY STAR® Certified.

### 10-YEAR FINISH WARRANTY\*

See pgs. 85-89 for paint and stain finishes.

Legacy Steel Doors with full-lite or half-lite decorative glass with ComforTech™ glazing will include a pane of Low-E glass in order to be ENERGY STAR certified. This includes the following styles; 150, 230, 239, 240, 350, 430, 437, 439 and 460. Since Low-E glass has a slight color tint, it is recommended that sidelites and transoms are ordered with optional Low-E pane to match the door.

## LEGACY STEEL DOOR STYLES

400 ○◆△	110 ◆	111 ◆△	112 ◆△	113 ◆	114 ◆△	115 ◆	116 ◆	437-1P ◆△	437-1PP ◆△	437-2P ○◆△	430-2P ○◆△	430-1P ◆	430-1PP ◆	230 ◆△	239 ◆△		
439 ◆△	440-1P ◆	440-2P ○◆	240 ○◆	150 ◆	350 ○◆	460 ○◆△	420S ◆	420-2P ◆	420-4P ○◆△	419-4P ○◆△	206 ○◆△	410 ○◆△	001 ○◆△	001S ◆	002 ◆		
002S ◆	003C ◆	003S ◆	002-440 ◆	002C-437 ◆	002CP-437 ◆	003 ◆	006 ○◆△	005S ◆	009 ◆	008 ◆	103M ◆	106 ◆	130 ◆	139 ◆	140 ◆	160 ◆	460 ○◆△

## SIDELITES

- 20-gauge Woodgrain Textured Steel
- ◆ 20-gauge Smooth Steel
- ❖ 20-gauge Smooth Steel with High-Definition Embossing
- ▲ 24-gauge Smooth or Textured Steel (used with all 20-gauge doors)
- 20-gauge smooth shaker
- △ Available in 30" Single or 60" French Doors

Entry System U-Factor: As low as .17 (Tested to NFRC specifications for a 6 panel door with wood frame).

\* Warranty time period may be limited in extreme applications. See warranty for details.

† Patent - USD621062

▲ NOT available as an Impact Shield product



Composite top endcaps increase rigidity and energy efficiency.

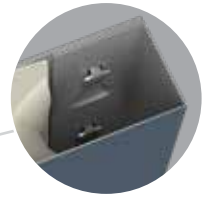

**Special adhesives/thermal barrier** reduce heat and cold transfer, while our exclusive tab and slot system of **mechanical interlocks** gives the door exceptional structural strength.

ProVia® doors are **foam filled by a computer driven process** that ensures the optimal foam fill for maximum energy efficiency and strength.

The edges and face skin of our steel doors are **one continuous piece of steel** for strength and durability.

To reinforce the lock and deadbolt area, we add a **rigid composite lock block** to all of our steel doors.

**Plugless Glass Trim** is optional on Legacy Steel. (see entryLINK for available styles)  
U.S. Patent: 9,562,389  
U.S. Patent: 9,976,338

Our 20-gauge steel doors give you **49% more galvanized steel** than a standard 24-gauge door.



Composite bottom endcaps increase rigidity and energy efficiency.

**Z-AC Threshold** with **auto-adjusting riser**. Standard with aluminum mill finish.



# 8' DOORS

---

Taller than standard doors, 8' doors provide a majestic first impression. Choose from many available glass and door styles. Multi-point hardware is required on all 8' fiberglass doors. See pages 93-98 for more information on PanoLock<sup>®</sup>+, Trilennium<sup>®</sup> and Hoppe<sup>®</sup> hardware.



Legacy 460 Style door painted Coal Black with Satin Nickel Schlage Addison Grip Handle and Waterfall Privacy Glass

## SIGNET® FIBERGLASS® DOOR STYLES



## SIDELITES

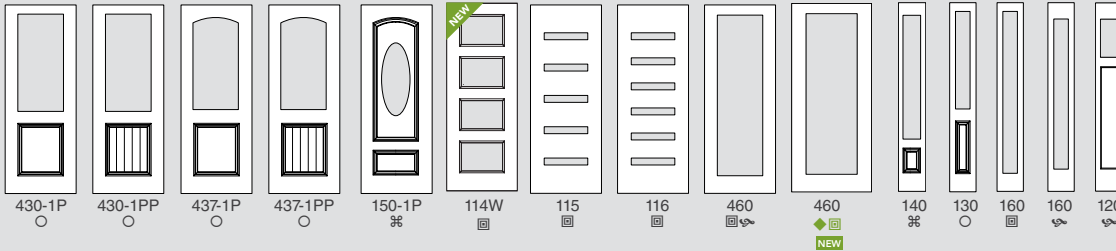

- ⌘ Signet Cherry
- Signet Mahogany
- + Signet Oak
- Signet Knotty Alder
- ⌘ Signet Fir
- ⊞ Signet Smooth
- ◆ Only available in 42" x 96" size

Entry System U-Factor: As low as .16 (Tested to NFRC specifications for a 6 panel door with wood frame).  
 Note: All Signet doors are shipped finished.

\* Warranty time period may be limited in extreme applications. See warranty for details.  
 † Patents - USD617005, USD621062, USD621063, USD625837, USD625024

## HERITAGE™ FIBERGLASS DOOR STYLES

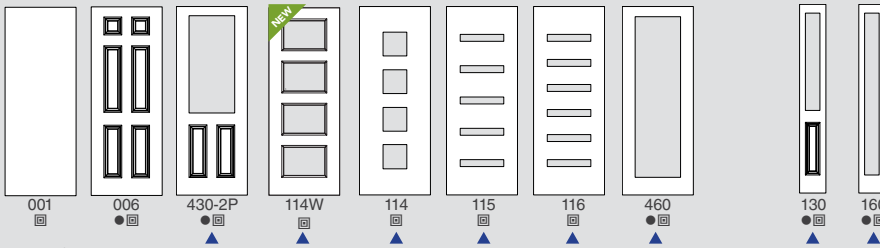

- Oak Grain
- ⊞ Smooth Fiberglass

Entry System U-Factor: As low as .14  
 (Tested to NFRC specifications for a 6 panel door with wood frame).

\* Warranty time period may be limited in extreme applications. See warranty for details.

## SIDELITES

## LEGACY™ STEEL DOOR STYLES

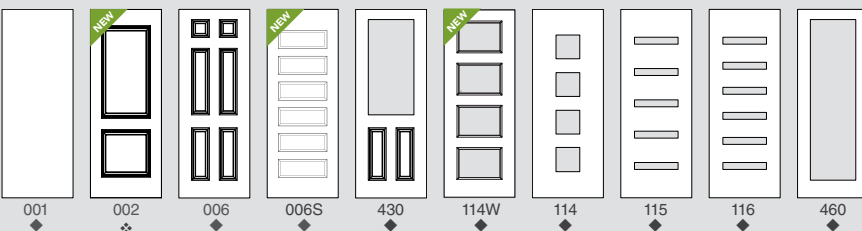

- 20-gauge Woodgrain Textured Steel
- ◆ 20-gauge Smooth Steel
- ❖ 20-gauge Smooth Steel with High-Definition Embossing
- ▲ 24-gauge Smooth or Textured Steel (used with all 20-gauge doors)

Entry System U-Factor: As low as .17 (Tested to NFRC specifications for a 6 panel door with wood frame).

\* Warranty time period may be limited in extreme applications. See warranty for details.

† Patent - USD621062

## SIDELITES

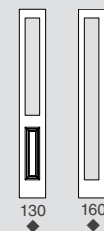

▲ NOT available as an Impact Shield product

# DOOR FEATURES

## SERIES COMPARISON CHART

	EMBARQ® FIBERGLASS	SIGNET® FIBERGLASS	HERITAGE™ FIBERGLASS	LEGACY™ STEEL
<b>Entry Door Slab</b>				
Slab Thickness	2½"	1¾"	1¾"	1¾"
Strike Stile	4¼" Finger-Jointed 4-ply Hardwood	4¼" Finger-Jointed 4-ply Hardwood	1⅞" Finger-Jointed, 2-Ply Solid Oak Laminated	Exclusive Steel Tab and Slot System
Hinge Stile	2⅝" Finger-Jointed 3-ply Hardwood	2⅝" Finger-Jointed 3-ply Hardwood	1⅞" Finger-Jointed, 2-Ply Solid Oak Laminated	Exclusive Steel Tab and Slot System
Top/Bottom Rail	Wood / Composite	Wood / Composite	Wood / Composite	Composite
Stile and Rail Construction	Dovetailed & Glued	Dovetailed & Glued	Nailed & Glued	Exclusive Steel Tab and Slot System
Glazing Package	Quad	Double, Triple	Double, Triple	Double, Triple
Woodgrain Texture	Nickle Vapor Deposition Technology	Nickle Vapor Deposition Technology	High Definition	Standard Definition
Strike and Hinge Door Edge	Skin Species	Skin Species	Oak	All Steel Advantage
Skin Species Availability	Mahogany, Cherry, Oak, Knotty Alder	Mahogany, Cherry, Oak, Knotty Alder, Fir & Smooth	Oak & Smooth	Woodgrain (Oak) & Smooth
Paint Finishing System	5-Step DuraFuse System Featuring P³ Fusion	5-Step DuraFuse System Featuring P³ Fusion	4-Step System	4-Step System
Stain Finishing System	7-Step DuraFuse System Featuring P³ Fusion	7-Step DuraFuse System Featuring P³ Fusion	5-Step System	5-Step System
Window Trim	Heat Resistant, Plugless Standard	Heat Resistant, Plugless Standard	Heat Resistant, Plugless Optional	Heat Resistant, Plugless Optional
Paint Colors	19 Standard 14 Trending	19 Standard 14 Trending	19 Standard 14 Trending	19 Standard 14 Trending
Stain Finishes	20 Finishes	20 Finishes	7 Finishes	7 Finishes
Glazed Finishes	7 Finishes	7 Finishes	N/A	N/A
Custom & Trending Finish Availability	Custom Paint, Custom Stains Trending Colors	Custom Paint, Custom Stains Trending Colors	Custom Paint Trending Colors	Custom Paint Trending Colors
Custom Sizing	⅞" Width & Height	⅞" Width & Height	⅞" Height	⅞" Width & Height



	EMBARQ® FIBERGLASS	SIGNET® FIBERGLASS	HERITAGE™ FIBERGLASS	LEGACY™ STEEL
<b>Entry Door System Components</b>				
Threshold Type	Z-AC Threshold with auto-adjusting riser	Z-AC Threshold with auto-adjusting riser	ZAI Threshold manually-adjustable riser	Z-AC Threshold with auto-adjusting riser
Security Plate	20-Gauge Steel	20-Gauge Steel	20-Gauge Steel	20-Gauge Steel
Adjustable Strike Plate	Exclusive Solid Brass with Dust Box	Exclusive Solid Brass with Dust Box	Exclusive Solid Brass with Dust Box	Exclusive Solid Brass with Dust Box
Sweep Type	Bulb and Blade	Bulb and Blade	Bulb and Blade	Bulb and Blade
Hinge Type	Heavy-Duty Ball Bearing Hinges	Heavy-Duty Ball Bearing Hinges	Heavy-Duty Ball Bearing Hinges	Heavy-Duty Ball Bearing Hinges
Weatherstripping	Energy Efficient Weatherstripping with CornerShield	Energy Efficient Weatherstripping with CornerShield	Energy Efficient Weatherstripping with CornerShield	Energy Efficient Weatherstripping with CornerShield
Interior Jamb Type	4 <sup>1</sup> / <sub>16</sub> " FrameSaver, Laminated Stained/Painted Color Matched Interior Jamb	4 <sup>1</sup> / <sub>16</sub> " FrameSaver, Laminated Stained/Painted Color Matched Interior Jamb	4 <sup>1</sup> / <sub>16</sub> " FrameSaver, Painted Color Matched Interior Jamb	4 <sup>1</sup> / <sub>16</sub> " FrameSaver, Painted Color Matched Interior Jamb

<b>Warranties</b>				
Paint and Stain Warranty*	15-year	15-year	10-year	10-year
Window Trim Warranty*	15-year	15-year	10-year	10-year
Jamb Warranty*	Lifetime	Lifetime	Lifetime	Lifetime
Slab Warranty*	Lifetime	Lifetime	Lifetime	Lifetime
Glass Warranty (Includes Glass Breakage Warranty)*	Lifetime	Lifetime	Lifetime	Lifetime

\*Some restrictions and exclusions apply. See warranty for details.

# FRENCH DOORS

French doors make an elegant statement like nothing else. Express your personality by creating a simple yet striking entry. Make it as ornate and beautiful as you like.

## FRENCH DOOR DETAILS

- All door styles are available as a French Door
- Hinged on each end with door knobs in the center
- Available with either left or right active door (main entryway)
- Center astragal is attached to the inactive door and includes top and bottom slide bolts (used to open inactive door)
- Available as inswing or outswing
- Header security plate standard on frame
- Hardware Installation: locksets, deadbolts and kickplates will be installed on active and inactive doors, all other hardware on active door only
- Available with Trilennium and PanoLock multi point hardware

## ASTRAGAL DETAILS The French Door Astragal provides functionality and security



Astragal secures inactive door at top and bottom of your french door system



Lockable throw bolts improve security



Astragal bolt penetrates threshold allowing boot to seal, creating a better barrier against the elements



Astragal is stained to match Signet Fiberglass stained doors.

## STYLES/CONFIGURATIONS

All door styles are available as a French Door. (See pages 9-20 for [Impact Shield](#) & [Windload](#) availability)

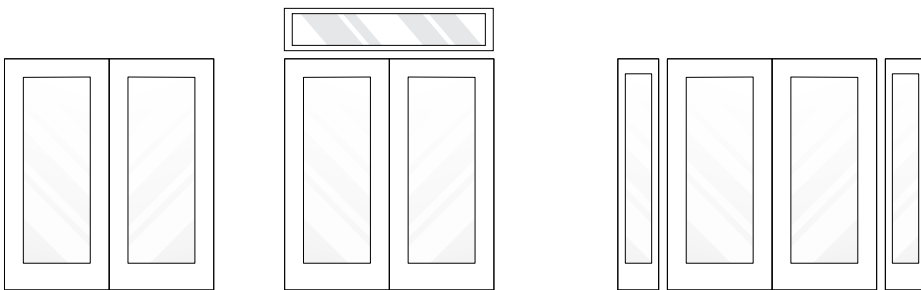

## UNEQUAL FRENCH DOORS

Unequal french doors allow you to use the larger entry door day-to-day, yet have the option to open the smaller, inactive door to gain full access.

Available in smooth steel only.  
Internal blind sizes are limited.  
See Price List for details.

# INSCRIBED DOORS

Elegant and refined to complement an entrance way. Each design is engraved into a Signet® Cherry fiberglass panel showcasing true richness of color and sophistication. Also available with three stainless steel inlay models.



Available in  
**CHERRY STAINS AND GLAZES**

**15-YEAR FINISH WARRANTY\***  
Signet Fiberglass

\*Warranty time period may be limited in extreme exposure applications. See warranty for details.

## INSCRIBED STYLES (Only available in flush Signet Cherry doors.)



001-INS3C



001-INS3-HN



001-INS6

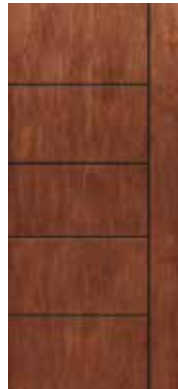

001-INS5

## STAINLESS STEEL INLAY STYLES (Only available in flush Signet Cherry doors.)



001-INL4



001-INL4S



001-INL6

# CLEAR GLASS

---

Clear Glass is a traditional option that looks fresh and stylish on every door, bringing simple elegance to your home's curb appeal. Practical and classic, clear glass offers unobscured views through exterior doors, allowing for full views of your property.

*See pages 9-20 for style availability*





Legacy™ 460 Style Smooth Steel French Entry  
Door painted Coal Black with Satin Brass Modern  
Rectangular Round Knob and Clear Glass

# COMFORTECH™

Measurably improve thermal performance with the ComforTech™ Warm Edge Glazing System. You'll enjoy better energy efficiency and a warmer glass edge.



## COMFORTECH ADVANTAGES



The NO-Metal Advantage



Mylar 10-Layer Vapor Barrier



Withstands Normal Bowing



Enhanced Noise Reduction

## COMFORTECH WARM EDGE GLAZING SYSTEM IS INCLUDED IN ALL:

- Decorative Glass
- Privacy Glass
- Art Glass
- Clear Glass
- Grids (Internal, External and SDL)

## GLAZING SYSTEM OPTIONS

ComforTech **TLK**  
ComforTech **TLK-UV**

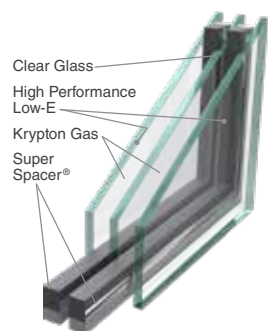

R-Value of 10

ComforTech **TLA**  
ComforTech **TLA-UV**

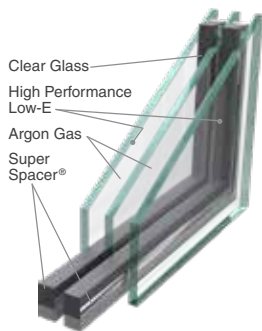

R-Value of 7

ComforTech **DLA**  
ComforTech **DLA-UV**

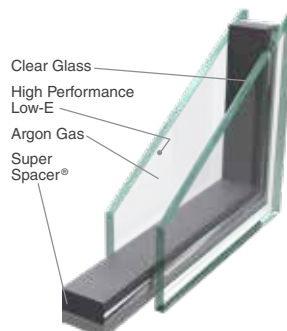

R-Value of 4

ComforTech **DC**

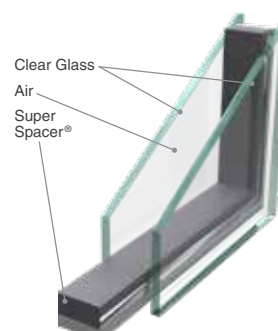

R-Value of 2

R-Value reflects properties of the glass only. Center of glass calculations are based upon software from Lawrence Berkeley National Laboratory.

## ELEVATION SERIES

for customers in high altitude areas

Insulated glass without Argon or Krypton. Capillary tubes are open and inserted behind glazing bead. Low-E softcoat and hardcoat available for vinyl patio doors.

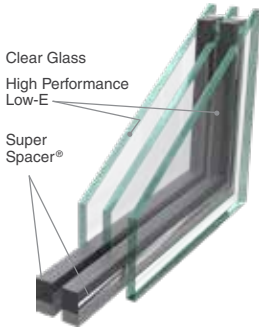

ComforTech **TLE**  
ComforTech **TLE-UV**

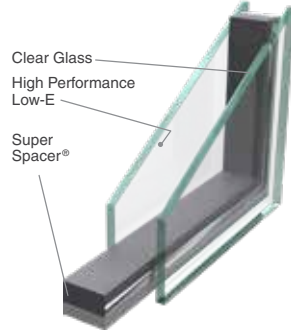

ComforTech **DLE**  
ComforTech **DLE-UV**

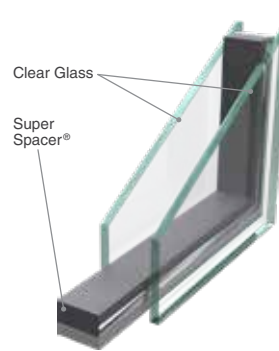

ComforTech **DE**



## Understanding the Acronyms

- T** - Triple Glazed
- D** - Double Glazed
- L** - Low E
- C** - Clear
- A** - Argon
- K** - Krypton
- E** - Elevation (no gas)
- UV** - Ultraviolet

Some Elevation Series (TLE-UV, TLE, DLE-UV and DLE) glass offerings require a hardcoat option to be ENERGY STAR® compliant.

## IMPACT SHIELD

All Impact Shield products feature ComforTech™ laminated glass.

ComforTech **TLK-C**  
ComforTech **TLK-UV-C**

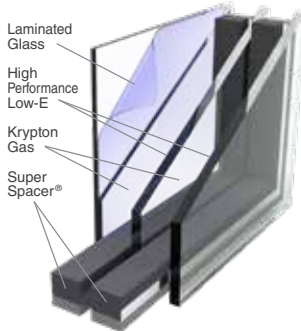

ComforTech **TLA-C**  
ComforTech **TLA-UV-C**



ComforTech **DLA-C**  
ComforTech **DLA-UV-C**

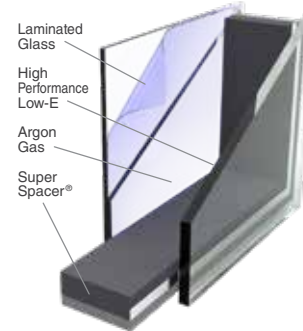

ComforTech **DC-C**

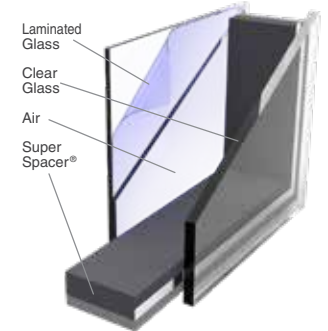

R-Value reflects properties of the glass only. Center of glass calculations are based upon software from Lawrence Berkeley National Laboratory.

## FLORIDA

Impact Shield products are designed to protect your family and home against the harshest storms and deter burglars. All entry systems and patio doors in this Impact Shield products section are wind-borne debris resistant and approved by the state of Florida. [floridabuilding.org](http://floridabuilding.org)

- Impact Shield
- Certified Wind Load
- High-Velocity Hurricane Zones  
(ProVia products have not been tested for use in High-Velocity Hurricane Zones)



**LIFETIME LIMITED WARRANTY**  
Includes Glass Breakage and Seal Failure

# SIMULATED DIVIDED LITES

Simulated Divided Lites (SDL) are reminiscent of old world craftsmanship when separate pieces of glass were mullioned together with wooden grids. We deliver that same stunning appearance through our high-tech stained fiberglass 1" wide x 1/32" thick grids combined with the energy efficient qualities of our ComforTech™ glass packages.



## CRAFTSMAN

Only available for Signet® Fir Series and Signet 420 Smooth.



## CONTOURED

Available for all styles shown, except for Signet Fir Series.



## BEVELED GLASS

The beauty of beveled glass and coming combine for a distinguished take on traditional divided lites.

Each piece of beveled glass is secured with coming for the beautiful look of a true divided light, with the efficiency of a single doorlight.

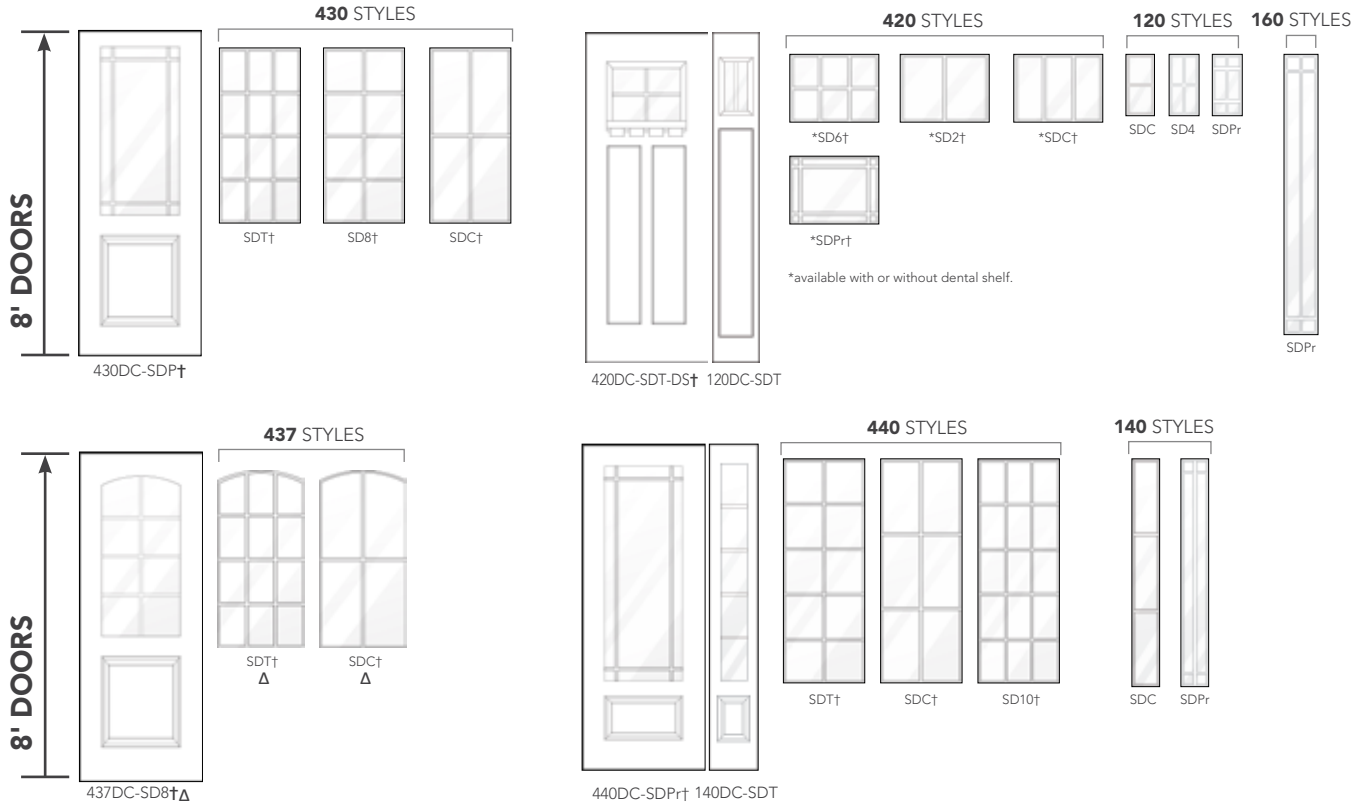

† For additional door panel styles see pg. 9 (for Embarq®), pg. 13 (for Signet®)

▲ Requires plugless trim

△ Not Available with beveled glass



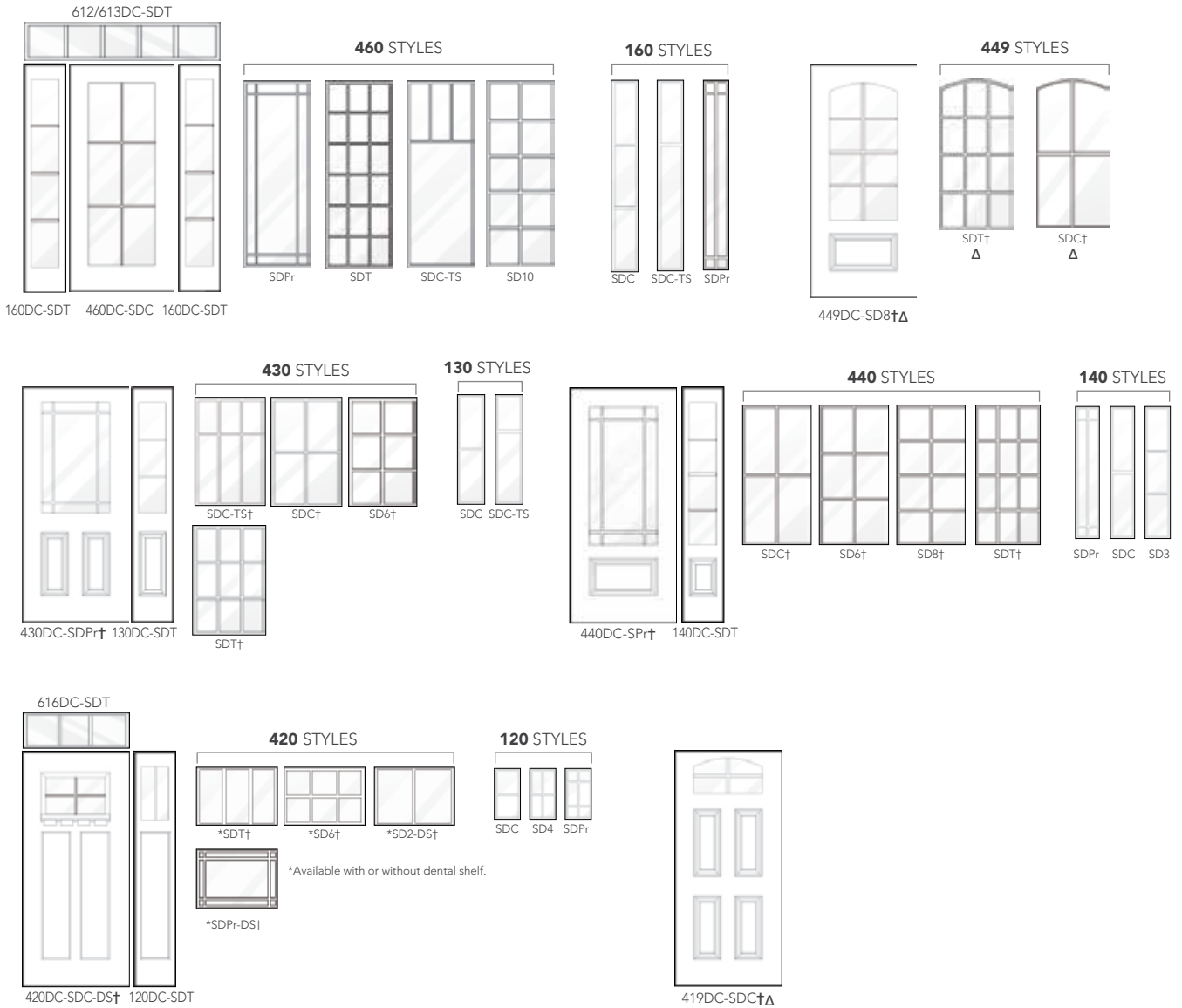

## SIMULATED DIVIDED LITES STYLE AVAILABILITY

(See pages 9-20 for [Impact Shield](#) & [Windload](#) availability)

	Doors					Sidelites				8' Doors				8' Sidelites				
	460	440	449	430	420	419	230	240	160	140	130	120	440	420	430	437	140	120
Embarq / Signet Mahogany Fiberglass	•	•		•		•			•	•								
Embarq / Signet Cherry Fiberglass	•	•	•	•		•			•	•			*					*
Embarq / Signet Oak Fiberglass	•	•		•		•			•	•								
Signet Fir Fiberglass					•							•						•
Embarq / Signet Knotty Alder Fiberglass	•			•					•					*	*			*
Signet Smooth Fiberglass	•	•							•	•								
Heritage Woodgrain Textured Fiberglass ▲	•	•		•		•			•	•	•							
Heritage Smooth Fiberglass ▲	•	•					•		•	•	•							
20-Gauge Woodgrain Textured Steel ▲	•	•		•				•	•	•	•							
20-Gauge Smooth Steel ▲	•	•		•			•	•	•	•	•							

† For additional door panel styles see pg. 9 (for Embarq®), pg. 13 (for Signet®)

\* Embarq doors and sidelites are not available in 8' heights

▲ Requires plugless trim

Δ Not Available with beveled glass



All entry systems with Simulated Divided Lites can be ENERGY STAR® Certified depending on the glazing system you choose. See entryLINK for which glazing system is required for ENERGY STAR certification, as well as for availability.

**LIFETIME LIMITED WARRANTY**  
Includes Glass Breakage & Seal Failure

Since Low-E glass has a slight color tint, it is recommended that sidelites are ordered with the same glazing system as the door.

All doors and sidelites with SDL's are available with privacy glass. SDL's match stain or paint of door.

# SIMULATED DIVIDED PANELS

For a stylish and modern look, Simulated Divided Panel fiberglass doors feature wider SDL's (3" and 5" options) applied to the surface of glass on 460 style Smooth or Fir doors. They may also be applied directly on the skin of a Smooth or Fir 001 style door. Numerous configurations and endless paint, glaze or stain colors allow you to create a door design that is contemporary, sophisticated and on-trend.

Available in Signet® Fir or Smooth with Clear glass or Privacy glass.  
 Simulated Divided Panel designs cannot be customized.



460-M3 Signet Fir Fiberglass entry door stained Truffle with Chinchilla privacy glass and a Satin Nickel Emtek™ Mortise Adelaide Handle

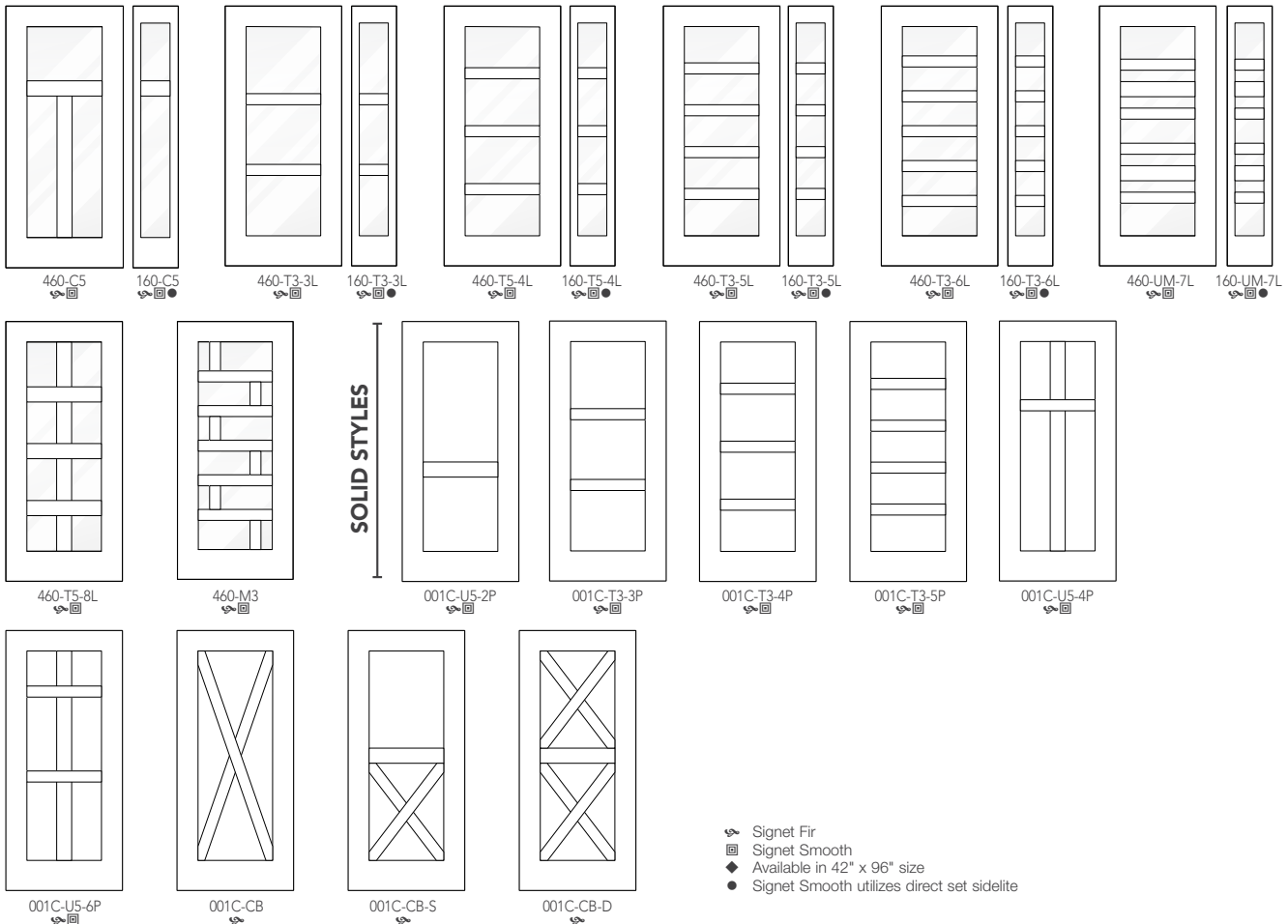

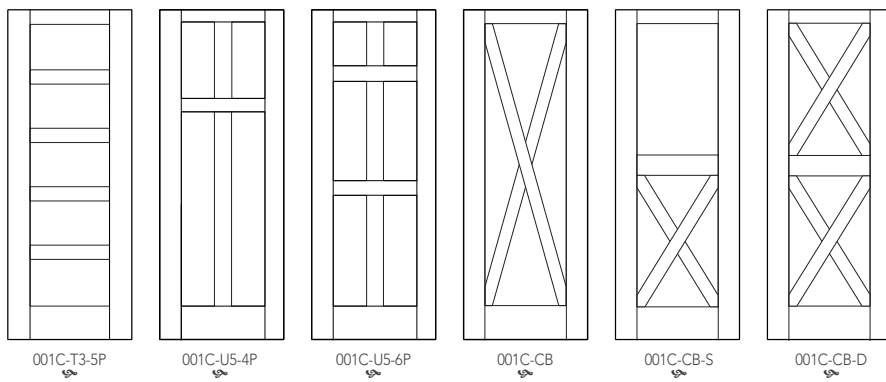
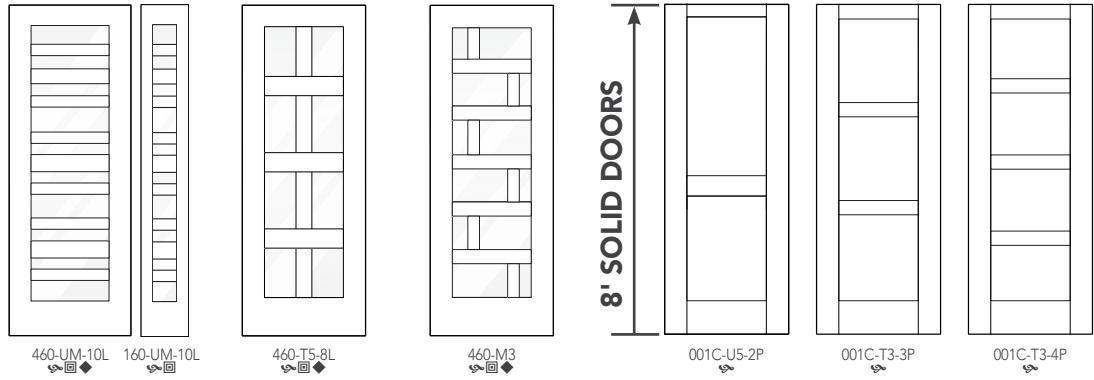
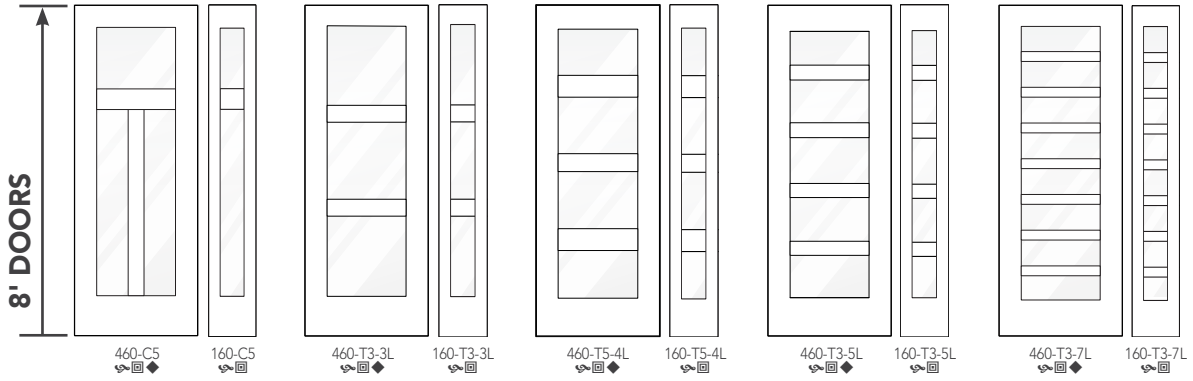

- 🌲 Signet Fir
- 🏠 Signet Smooth
- ◆ Available in Smooth 42" x 96" size



All 8' Signet Smooth doors with Simulated Divided Panels will have raised flat trim around the glass, as shown here.

# INTERNAL GRIDS



## INTERNAL GRID OPTIONS

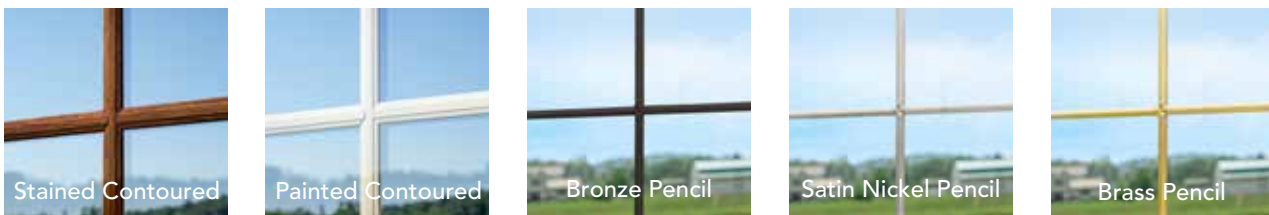

\*Pencil Grids are not available in Single/Double Prairie Grids on some doors and transoms.

## CONTOURED GRID **COLORS AND STAINS**

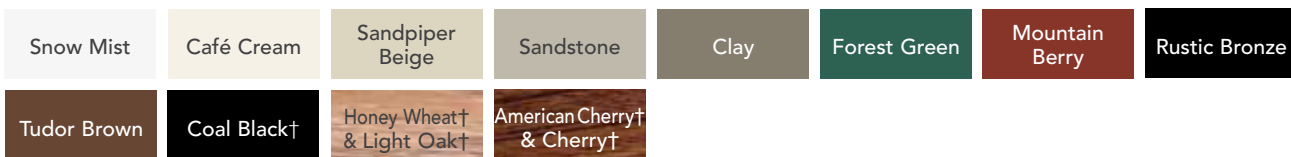

## **TWO-TONE** CONTOURED GRIDS



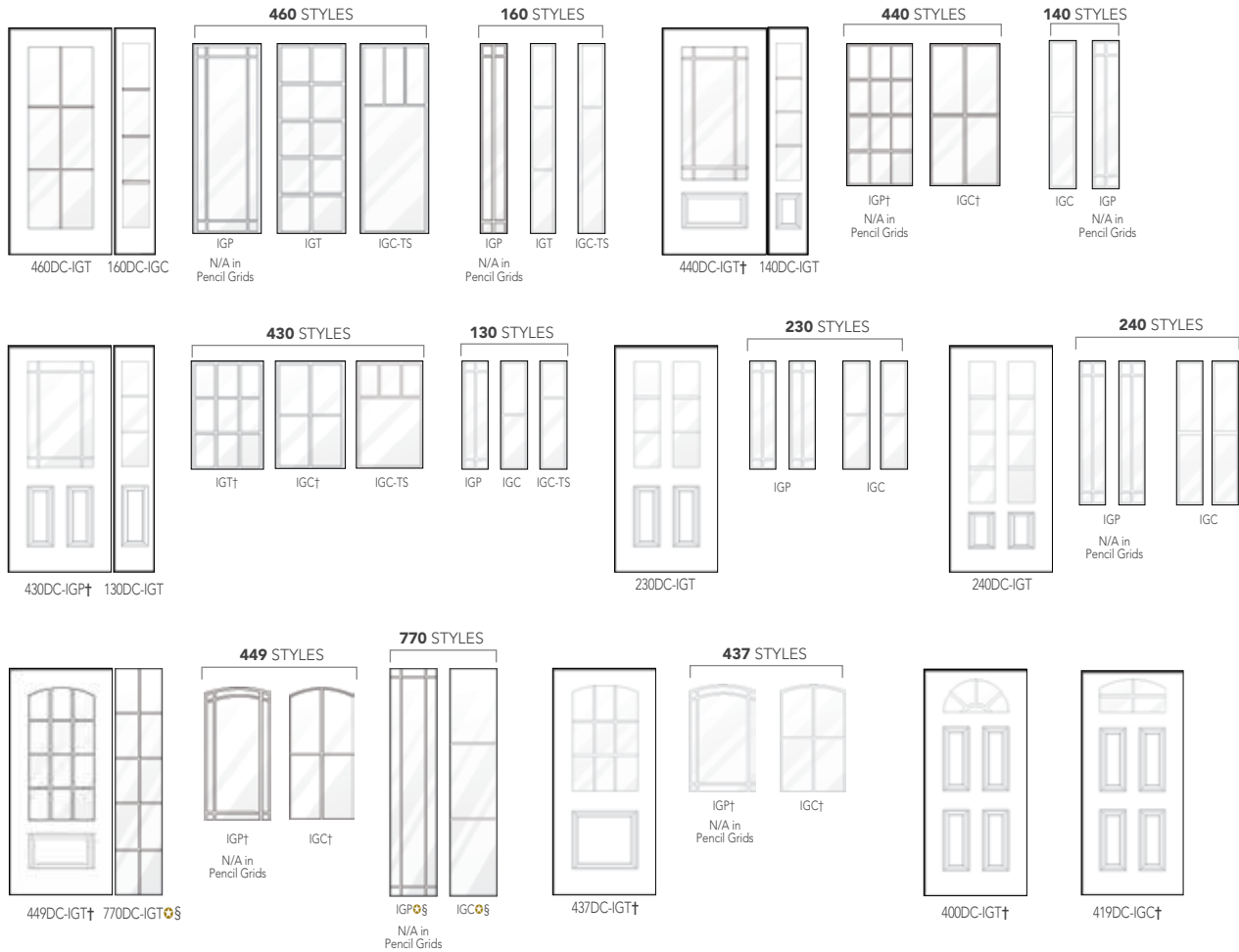

§ Also available in 10" width.  
 \*\* Requires an additional 4-week lead time  
 † For additional door panel styles see pg.9 (for Embarq®), pg.13 (for Signet®), pg. 15 (for Heritage™) or pg. 17 (for Legacy™)  
 ‡ Cannot be mulled with Heritage Fiberglass doors in Certified Wind Load regions  
 \* In Certified Wind Load region, indicated transoms must be installed in a separate opening or use approved engineering mulls

## TRANSOMS



512/513DC-IGS‡  
Not available in Pencil Grids



516DC-IGS\*



712/713DC-IGS\*\*‡  
Not available in Pencil Grids



532DC-IGS\*



612/613DC-IGS‡  
Not available in Pencil Grids



612/613DC-IGT‡



616DC-IGT‡



616DC-IGP‡

# INTERNAL GRIDS CONT'D

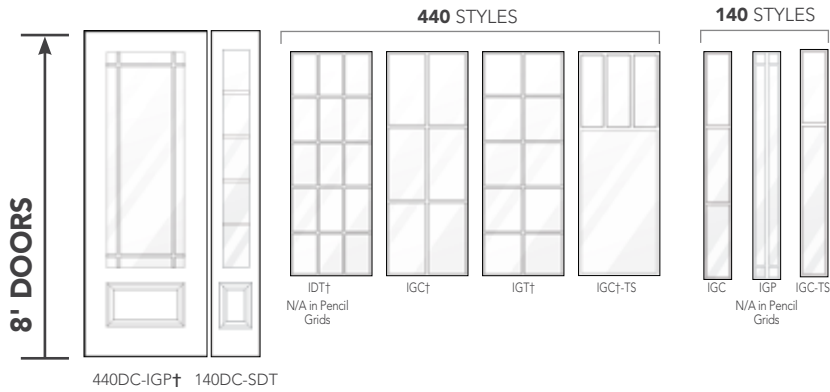

- § Also available in 10" width.
- \*\* Requires an additional 4-week lead time
- † For additional door panel styles see pg. 9 (for Embarq®), pg. 13 (for Signet®), pg. 15 (for Heritage™) or pg. 17 (for Legacy™)
- ✦ Cannot be mullied with Heritage Fiberglass doors in Certified Wind Load regions
- \* In Certified Wind Load region, indicated transoms must be installed in a separate opening or use approved engineering mulls

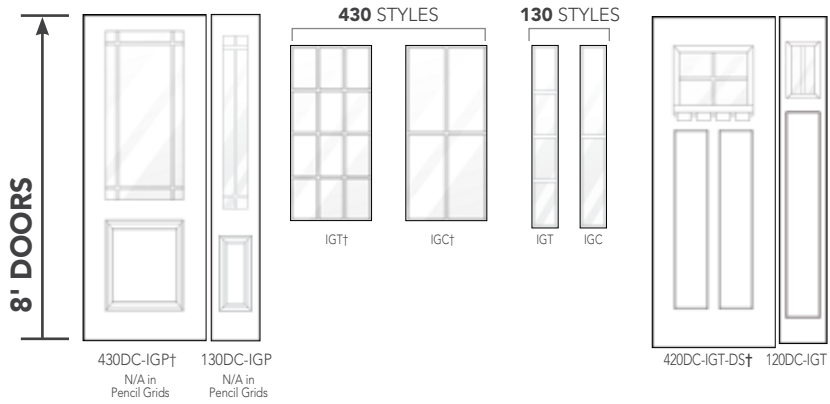

\*available with or without dental shelf.

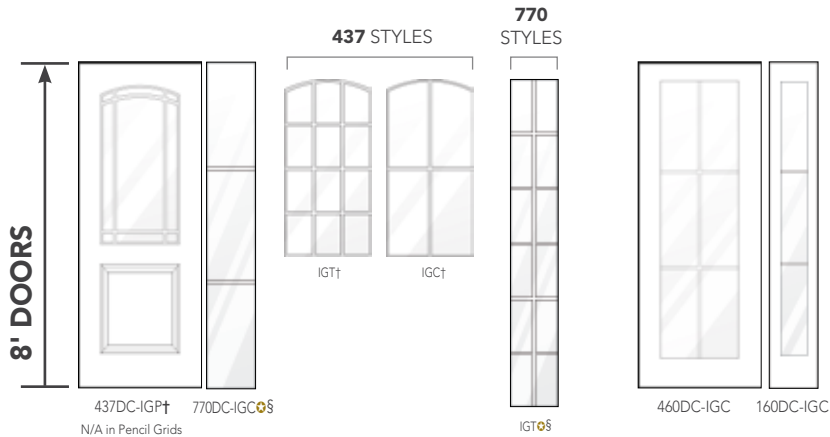

## INTERNAL GRIDS STYLE AVAILABILITY

	Doors								Sidelites				8' Doors					8' Sidelites								
	460	449	440	437	430	240	230	420	419	400	770	160	140	130	120	460	420	440	430	437	160	140	130	120	770	
Embarq / Signet Mahogany Series	•	•	•	•	•	•	•	•	•	•	•	•	•	•	•											
Embarq / Signet Cherry Series	•	•	•	•	•	•	•	•	•	•	•	•	•	•	•		*									*
Embarq / Signet Oak Series	•	•	•	•	•	•	•	•	•	•	•	•	•	•	•											
Signet Fir Series	•	•	•	•	•	•	•	•	•	•	•	•	•	•	•											•
Embarq / Signet Knotty Alder Series	•	•	•	•	•	•	•	•	•	•	•	•	•	•	•		*	*								*
Signet Smooth Series	•	•	•	•	•	•	•	•	•	•	•	•	•	•	•											•
Heritage Textured Fiberglass	•	•	•	•	•	•	•	•	•	•	•	•	•	•	•											•
Heritage Smooth Fiberglass	•	•	•	•	•	•	•	•	•	•	•	•	•	•	•											•
20-Gauge Woodgrain Textured Steel	•	•	•	•	•	•	•	•	•	•	•	•	•	•	•											•
20-Gauge Smooth Steel	•	•	•	•	•	•	•	•	•	•	•	•	•	•	•											•

\* Embarq doors and sidelites are not available in 8' heights  
 o Steel sidelites are made from 24-Gauge steel



All entry systems with Internal Grids can be ENERGY STAR® Certified depending on the glazing system you choose. See entryLINK for which glazing system is required for ENERGY STAR certification, as well as for availability.

# EXTERNAL GRIDS



External grids will match the door's paint or stain color.

## EXTERNAL GRID STYLE AVAILABILITY

	Doors						Sidelites	
	460	430	439	230	410	400	160	130
Heritage Woodgrain Textured Fiberglass	•	•	•	•	•	•	•	•
Heritage Smooth Fiberglass	•	•	•	•	•	•	•	•
20-Gauge Woodgrain Textured Steel	•	•	•		•	•	○	○
20-Gauge Smooth Steel	•	•	•	•	•	•	○	○



All entry systems with External Grids can be ENERGY STAR® Certified depending on the glazing system you choose. See entryLINK for which glazing system is required for ENERGY STAR certification, as well as for availability.

† For additional door panel styles see pg. 15 (for Heritage™) or pg. 17 (for Legacy™)  
 Δ Not available in 1" ComforTech Glazing System. Also, window trim screw plugs are not available for this door style.  
 ○ Steel sidelites are made from 24-Gauge steel

**LIFETIME LIMITED WARRANTY**  
 Includes Glass Breakage & Seal Failure

# WHITE INTERNAL BLINDS

Internal blinds are a convenient option for blocking harsh sunlight and increasing privacy on entry doors and patio doors.

Constructed with sturdy aluminum and enclosed in tempered safety glass, the blinds are protected from weathering, damage, dust and they are not a hindrance to cleaning your glass.



Blind operator as viewed from the interior of your home.

## AVAILABLE DOOR STYLES

Available with clear glass and internal grids.

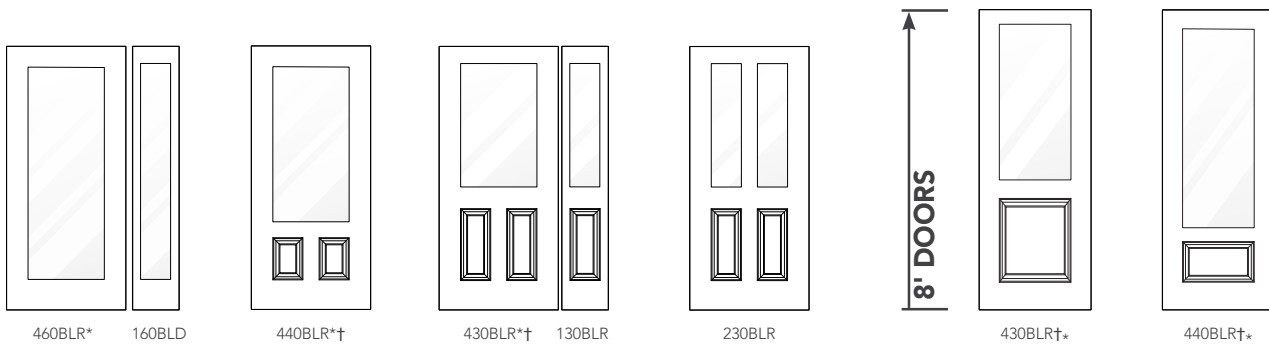

† For additional door panel styles see pg. 14 (for Signet®), pg. 16 (for Heritage™) or pg. 18 (for Legacy™)  
 \* On Signet doors, blind operator will be operator pictured on page 90

## FEATURES

- Ergo Track on glass
- Eliminated Slat/Privacy Channel Gap
- U-Privacy Channels (side, top & bottom) eliminate light gaps, shadows and sunlight glare
- Full Tilt Closure (top to bottom) allows the blinds to tilt completely closed keeping unwanted light out

## NEW

Available as an Impact Shield rated product and tested for Certified Windload Regions.



# COLORED INTERNAL BLINDS

Internal blinds are available in several neutral hues to complement any room in the house. Easy to clean; no more dusting of blinds. Internal blinds are suitable for entry doors and patio doors. Offering a 10-Year Warranty.



Blind operator as viewed from the interior of your home.

## AVAILABLE DOOR STYLES

Available with clear glass and internal grids.

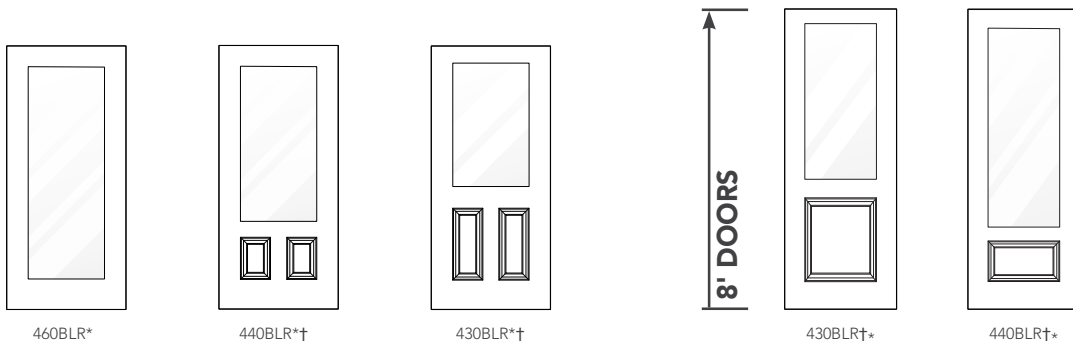

## AVAILABLE COLORS



Cream



Tan



Silver



Champagne



**NEW** Black

# PRIVACY GLASS

Privacy glass ensures a high level of obscurement but allows soft light to filter in and illuminate a space.

## PRIVACY RATING SCALE

1 2 3 4 5 6 7 8 9 10

less privacy

more privacy



\* Mistify and Twilight privacy glass only available on select door styles. See entryLINK for details.

*These photos were taken with objects directly behind the privacy glass in a well-lit space. Actual privacy levels will vary depending on your distance from the glass and also the amount of light in the room in comparison to the light outside your home.*

*For extra privacy, contact customer service to add an extra pane of privacy glass to your door or window order.*

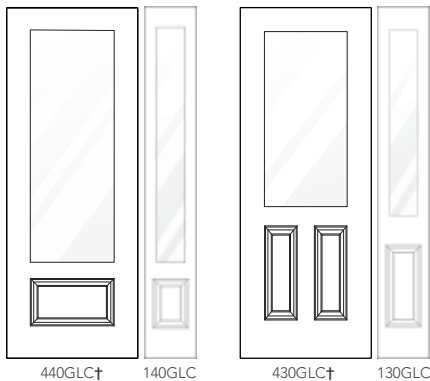
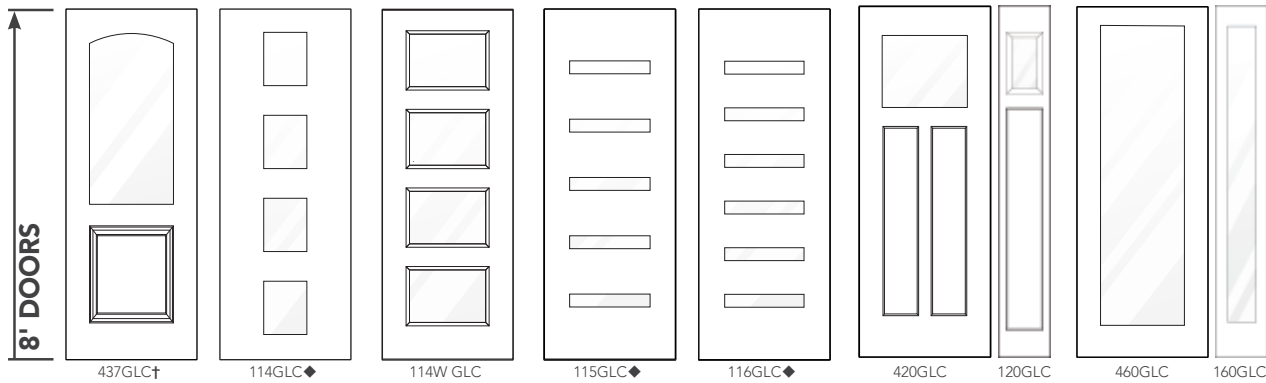
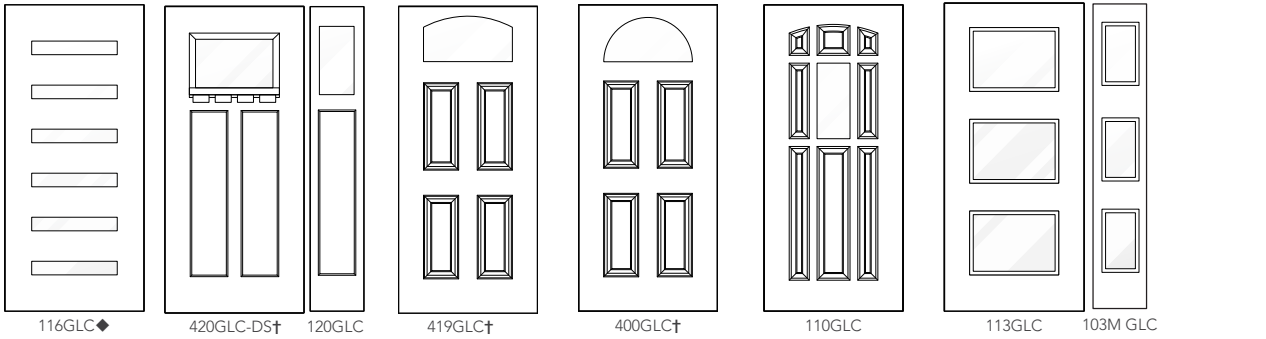
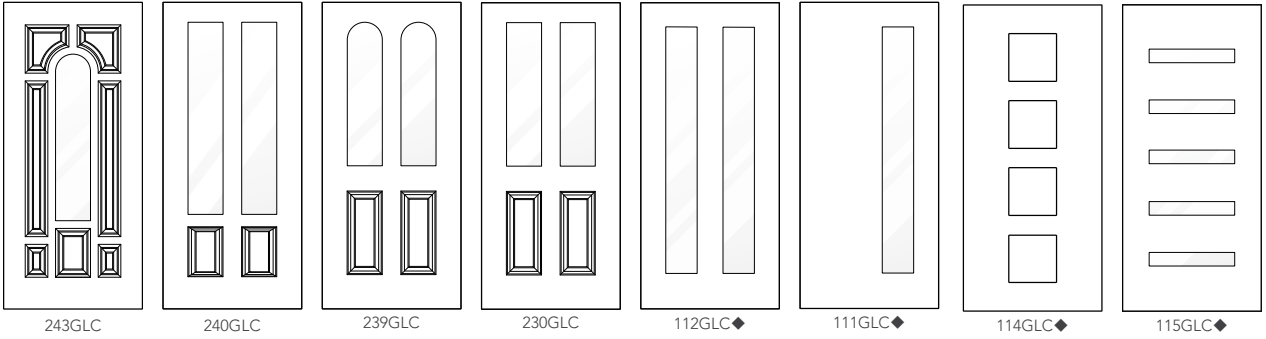
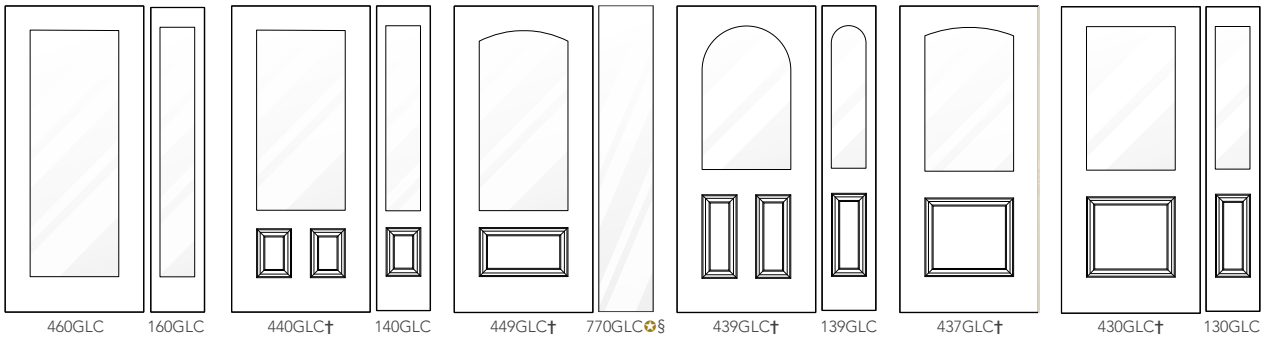

Since Low-E glass has a slight color tint, it is recommended that sidelites be ordered with the same glazing system as the door.

**LIFETIME LIMITED WARRANTY**  
Includes Glass Breakage & Seal Failure

**Note** - Privacy glass is available in Simulated Divided Lites (see pg. 29) Simulated Divided Panels (pg. 31) and External Grids (see pg 36).

See entryLINK for which glazing system is required for ENERGY STAR certification, as well as for availability.

† For additional door panel styles see pg. 10 (for Embarq®), pg. 14 (for Signet®), pg. 16 (for Heritage™) or pg. 18 (for Legacy™)

§ Also available in 10" width.

◆ Cannot be mullied with Heritage Fiberglass doors in Certified Wind Load regions

◆ Only available with Modern Flat Glass Trim. Only available with 770 sidelite(s) or 160 sidelite(s) with Modern Flat Glass Trim.

# DECORATIVE GLASS

---

Decorative glass is unique in that it achieves its personality and beauty through aesthetic imperfections – waves, striations, and air bubbles that create natural effects and singular characteristics. ProVia® decorative glass mimics the hand-made sheet glass of centuries past, and these stunning ornamental designs elevate the look of entry doors and windows, boosting the curb appeal of your home.

All ProVia decorative glass designs include the ComforTech™ Warm Edge Glazing System, which measurably improves its thermal performance and energy efficiency. Impact Shield laminated glass reinforcement is available as an upgrade, fortifying the decorative glass to withstand windborne storm debris and repeated blows.



### ProVia Exclusive

These decorative glass designs are only found on ProVia doors and windows. This gives your home a unique style that can't be found anywhere else.



### Covered by a Lifetime Limited Warranty

Warranty includes glass breakage and seal failure.



### Available on Entry Doors and Windows

Watch the Decorative Glass creation process here!



For more styles and configurations, visit [provia.com](http://provia.com) or scan this code.



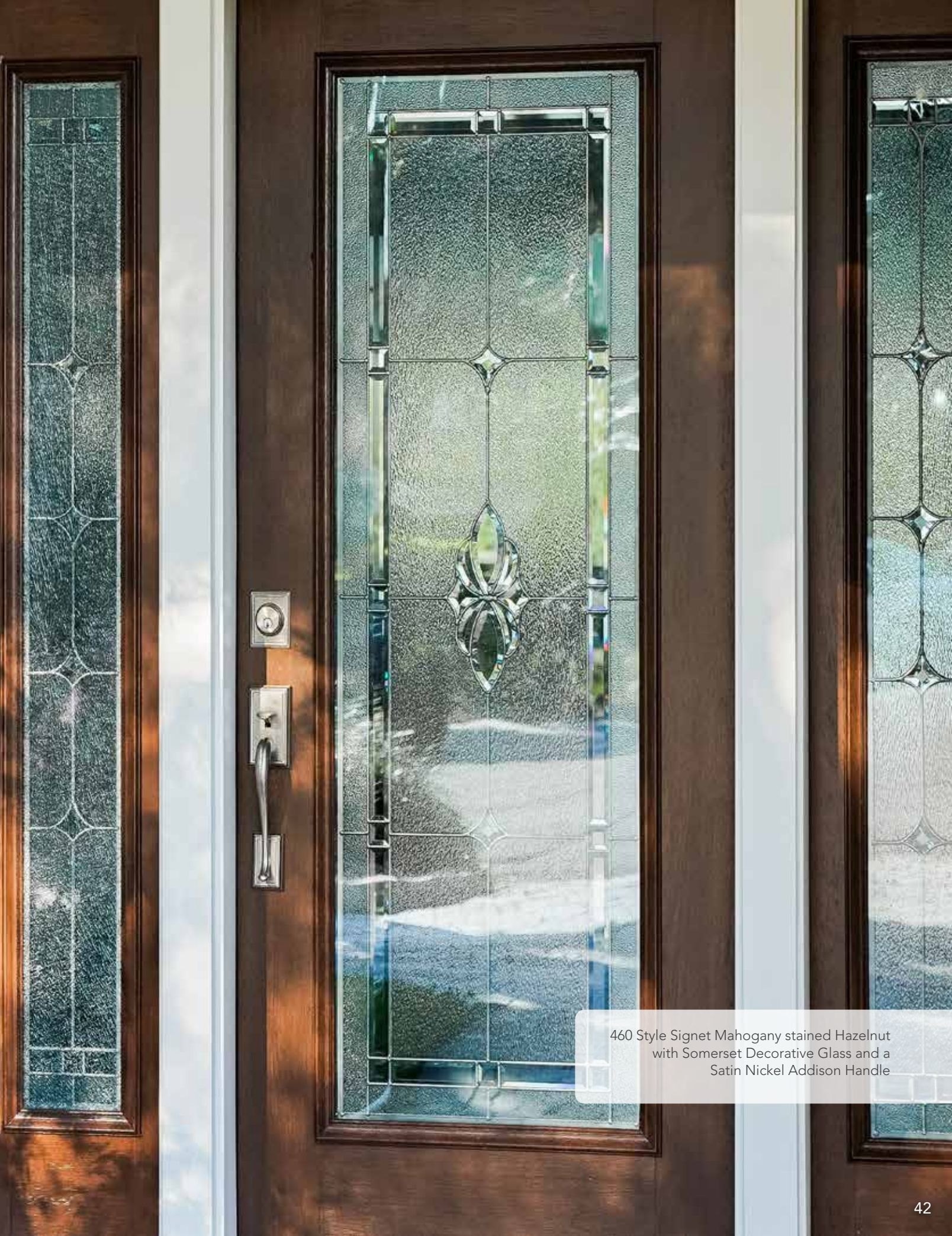

460 Style Signet Mahogany stained Hazelnut with Somerset Decorative Glass and a Satin Nickel Addison Handle



GRAY TINTED GLASS

BEVELED

MICROCUBED

HAMMERED



# BROOKHAVEN

## DECORATIVE GLASS

Brookhaven is accented with gray tint glass, giving it a subtle hint of color. The hammered glass delivers some privacy and is accentuated with clear beveled and microcubed glass throughout.

### CAMING FINISH



### PRIVACY RATING

1 2 3 4 5 6 7 **8** 9 10

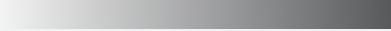

less privacy                      more privacy

### LIFETIME LIMITED WARRANTY

Includes Glass Breakage & Seal Failure



Most full wood frame and composite frame entry systems using Brookhaven Glass are ENERGY STAR® Certified. See the ENERGY STAR section of our website for energy ratings on specific styles.

612/613BRO



160BRO 460BRO



140BRO 440BRO†



449BRO



350BRO



150BRO†



240BRO



243BRO



130BRO 430BRO†



439BRO †



230BRO



139BRO 239BRO



120BRO 420BRO-DS



419BRO†



400BRO†

8' DOORS

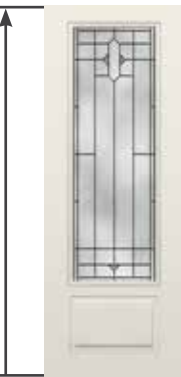

440BRO†



140BRO



430BRO†



130BRO



437BRO†



150BRO

§ Also available in 10" width (which requires an additional 4-week lead time). See Price List for design pattern  
† Requires an additional 6-week lead time

† For additional door panel styles see pg. 9 (for Embarq®), pg. 13 (for Signet®), pg. 15 (for Heritage™) or pg. 17 (for Legacy™)  
⊕ Cannot be mullied with Heritage Fiberglass doors in Certified Wind Load regions

BEVELED

SEEDY

ARCTIC

# CARLISLE

DECORATIVE GLASS

Ornamental flourishes paired with clear bevels and arctic and seedy glass give Carlisle a warm, graceful and hospitable design.

## CAMING FINISH

Zinc

Patina



## PRIVACY RATING

1 2 3 4 5 6 **7** 8 9 10

less privacy

more privacy

## LIFETIME LIMITED WARRANTY

Includes Glass Breakage & Seal Failure





Most full wood frame and composite frame entry systems using Carlisle Glass are ENERGY STAR® Certified. See the ENERGY STAR section of our website for energy ratings on specific styles.



§ Also available in 10" width (which requires an additional 4-week lead time). See Price List for design pattern  
 † Requires an additional 6-week lead time

† For additional door panel styles see pg. 9 (for Embarq®), pg. 13 (for Signet®), pg. 15 (for Heritage™) or pg. 17 (for Legacy™)  
 ‡ Cannot be mullied with Heritage Fiberglass doors in Certified Wind Load regions

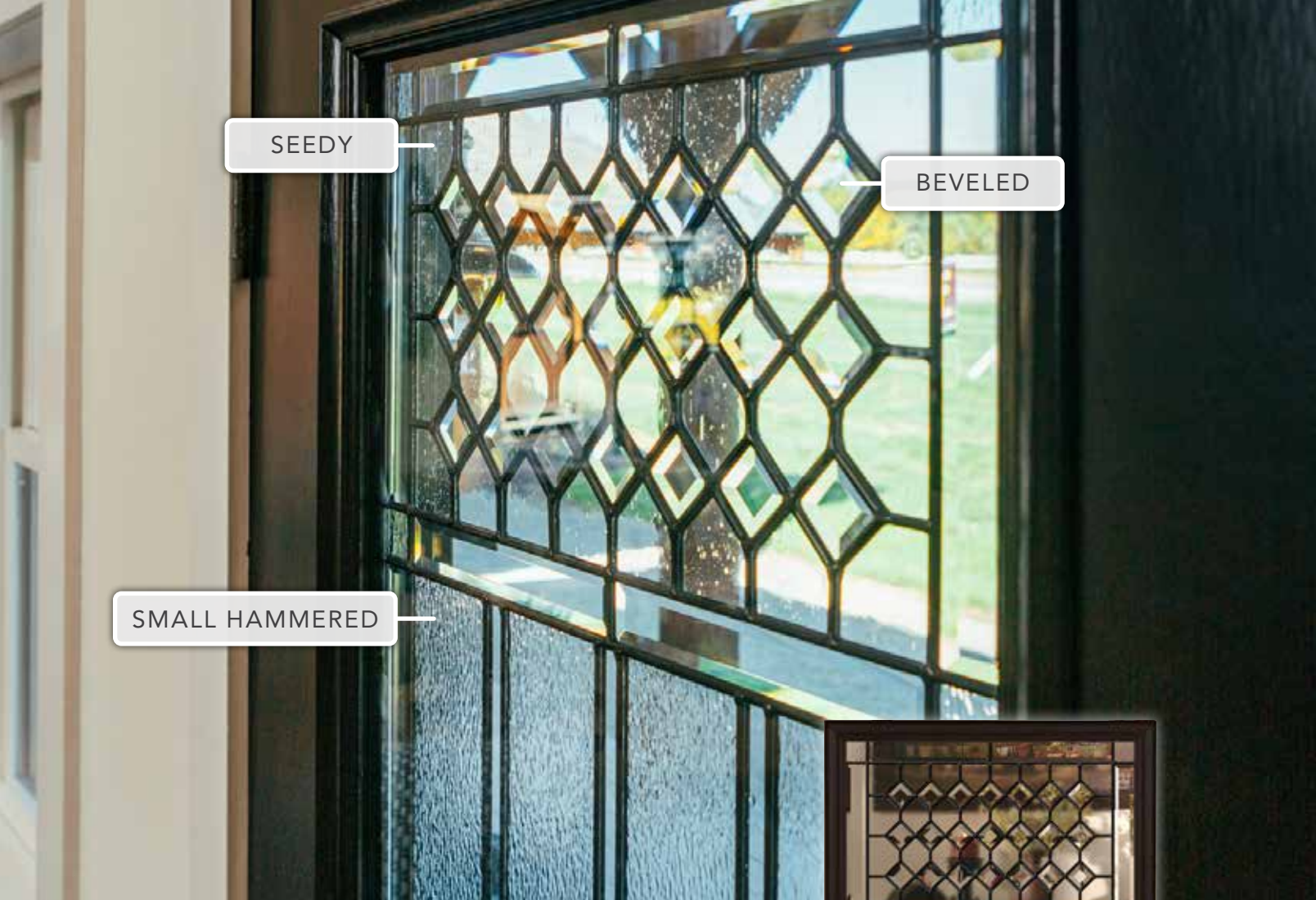

SEEDY

BEVELED

SMALL HAMMERED

# CARRINGTON

DECORATIVE GLASS

Carrington features small hammered, flat seedy and clear bevels in an attractive vintage design to accent your home.

## CAMING FINISH

Patina



## PRIVACY RATING

1 2 3 4 **5** 6 7 8 9 10

less privacy

more privacy

## LIFETIME LIMITED WARRANTY

Includes Glass Breakage & Seal Failure



Most full wood frame and composite frame entry systems using Carrington Glass are ENERGY STAR® Certified. See the ENERGY STAR section of our website for energy ratings on specific styles.

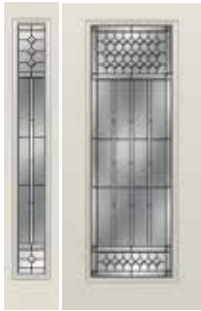
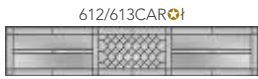

160CAR



460CAR



140CAR



440CAR†



130CAR



430CAR†

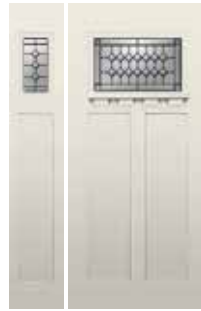

120CAR



420CAR-DS



770CAR\*†



449CAR†



243CAR



240CAR



230CAR



419CAR†



440CAR†



140CAR



430CAR†



130CAR



437CAR†

§ Also available in 10" width (which requires an additional 4-week lead time). See Price List for design pattern  
† Requires an additional 6-week lead time

† For additional door panel styles see pg. 9 (for Embarq®), pg. 13 (for Signet®), pg. 15 (for Heritage™) or pg. 17 (for Legacy™)  
\* Cannot be mullied with Heritage Fiberglass doors in Certified Wind Load regions



GLUECHIP

GRAY SOFTWARE

BEVELED GLUECHIP



# CONSTANCE

## DECORATIVE GLASS

Constance features gluechip, medium gray software and beveled edge gluechip resulting in a traditional design with an elegant look.

### CAMING FINISH



Brass



Zinc

### PRIVACY RATING

1 2 3 4 5 **6** 7 8 9 10



less privacy

more privacy

### LIFETIME LIMITED WARRANTY

Includes Glass Breakage & Seal Failure



Most full wood frame and composite frame entry systems using Constance Glass are ENERGY STAR® Certified. See the ENERGY STAR section of our website for energy ratings on specific styles.



§ Also available in 10" width (which requires an additional 4-week lead time). See Price List for design pattern  
 † Requires an additional 6-week lead time

‡ For additional door panel styles see pg. 9 (for Embarq®), pg. 13 (for Signet®), pg. 15 (for Heritage™) or pg. 17 (for Legacy™)  
 ‡ Cannot be mulled with Heritage Fiberglass doors in Certified Wind Load regions

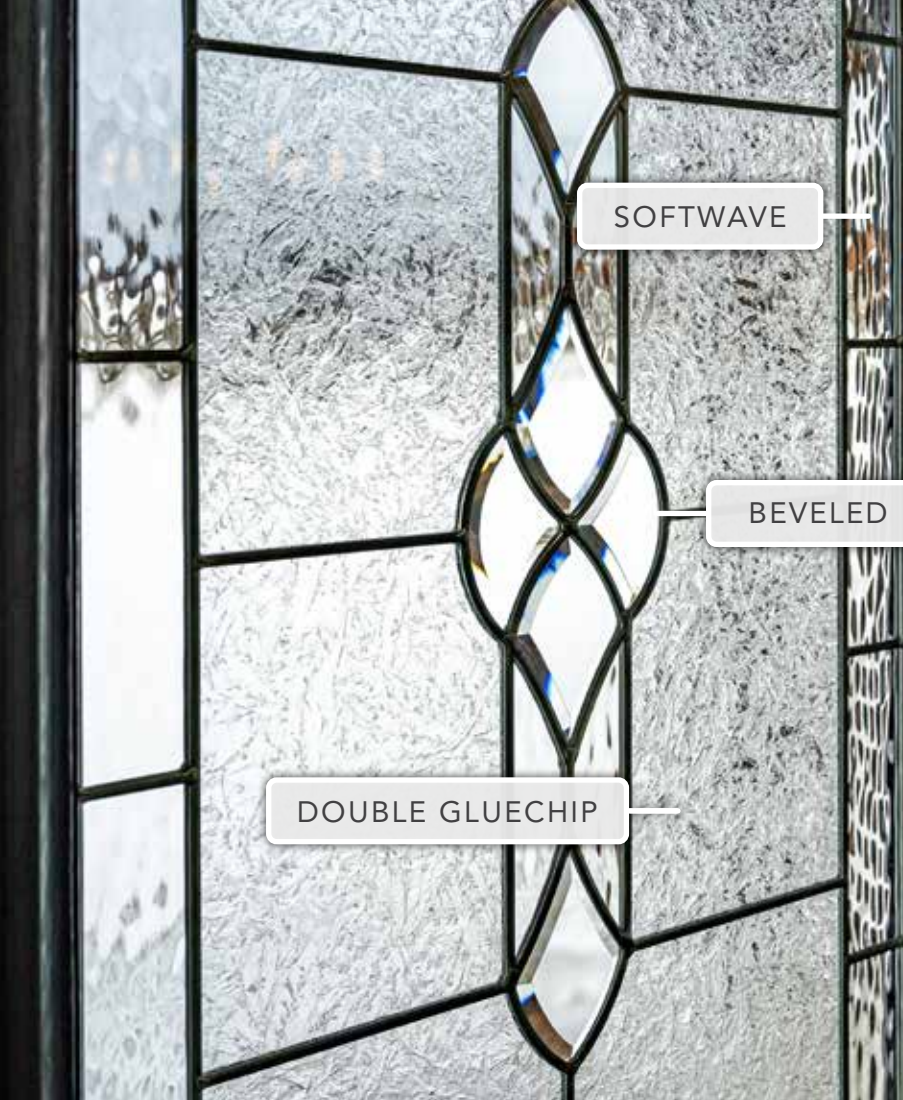

SOFTWAVE

BEVELED

DOUBLE GLUECHIP



# ECLIPSE

## DECORATIVE GLASS

Eclipse features double gluechip and clusters of beveled glass with a traditional and harmonious design. Eclipse promotes classical elegance and privacy.

### CAMING FINISH



Brass

Zinc

Patina

### PRIVACY RATING

1 2 3 4 5 6 **7** 8 9 10

less privacy

more privacy

### LIFETIME LIMITED WARRANTY

Includes Glass Breakage & Seal Failure



Most full wood frame and composite frame entry systems using Eclipse Glass are ENERGY STAR® Certified. See the ENERGY STAR section of our website for energy ratings on specific styles.

612/613ECB†

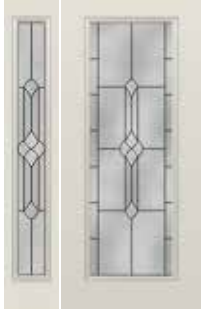

160ECB 460ECB



350ECB



150ECB†



243ECB



130ECB 430ECB†



439ECB†



230ECB



419ECB†



400ECB†



110ECB

8' DOORS

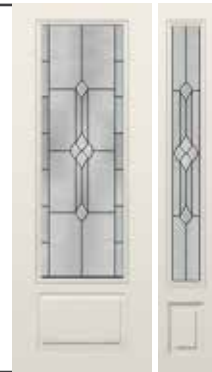

440ECB† 140ECB



150ECB

† For additional door panel styles see pg. 9 (for Embarq®), pg. 13 (for Signet®), pg. 15 (for Heritage™) or pg. 17 (for Legacy™)  
 ‡ Requires an additional 6-week lead time  
 † Cannot be mullied with Heritage Fiberglass doors in Certified Wind Load regions



SMALL HAMMERED

SEEDY

BEVELED

MICRO GRANITE



# ESMOND

## DECORATIVE GLASS

Esmond features small hammered, micro granite, flat seedy and clear bevels in a splendid old-world style design bringing a unique touch to your home.

### CAMING FINISH

Patina

### PRIVACY RATING

1 2 3 4 5 **6** 7 8 9 10



less privacy                      more privacy

### LIFETIME LIMITED WARRANTY

Includes Glass Breakage & Seal Failure





Most full wood frame and composite frame entry systems using Esmond Glass are ENERGY STAR® Certified. See the ENERGY STAR section of our website for energy ratings on specific styles.



§ Also available in 10" width (which requires an additional 4-week lead time). See Price List for design pattern  
 † Requires an additional 6-week lead time

† For additional door panel styles see pg. 9 (for Embarq®), pg. 13 (for Signet®), pg. 15 (for Heritage™) or pg. 17 (for Legacy™)  
 ☼ Cannot be mullied with Heritage Fiberglass doors in Certified Wind Load regions



# ESSENCE

DECORATIVE GLASS

Essence features a bronze seedy glass combined with micro granite that brings elegance to a whole new level.

## CAMING FINISH



## PRIVACY RATING

1 2 3 4 5 **6** 7 8 9 10

less privacy

more privacy

**LIFETIME LIMITED WARRANTY**  
Includes Glass Breakage & Seal Failure



Most full wood frame and composite frame entry systems using Essence Glass are ENERGY STAR® Certified. See the ENERGY STAR section of our website for energy ratings on specific styles.

612/613ESZ☼†



160ESZ 460ESZ



140ESZ 440ESZ†



770ESZ☼§† 150ESZ†



240ESZ



130ESZ 430ESZ†



230ESZ

8' DOORS



440ESZ†



140ESZ



430ESZ†



130ESZ



150ESZ

† For additional door panel styles see pg. 9 (for Embarq®), pg. 13 (for Signet®), pg. 15 (for Heritage™) or pg. 17 (for Legacy™)  
 § Also available in 10" width (which requires an additional 4-week lead time). See Price List for design pattern  
 ‡ Requires an additional 6-week lead time  
 ☼ Cannot be mulled with Heritage Fiberglass doors in Certified Wind Load regions

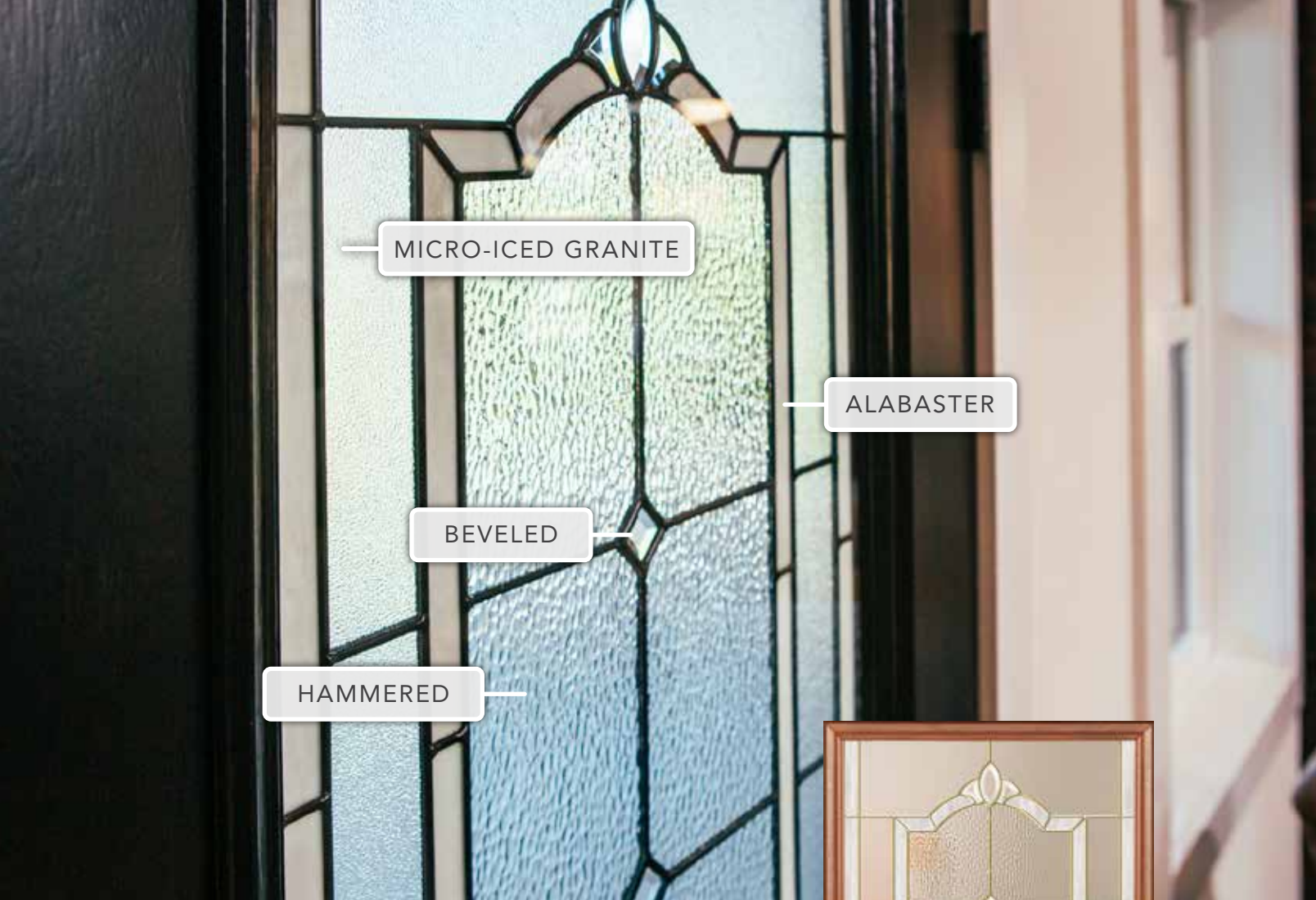

MICRO-ICED GRANITE

ALABASTER

BEVELED

HAMMERED

# FLORENCE

## DECORATIVE GLASS

This traditional style is accented with a creamy alabaster glass adding interest and appeal that clearly sets it apart from other decorative designs.

### CAMING FINISH

Brass

Patina



### PRIVACY RATING

1 2 3 4 5 6 7 **8** 9 10

less privacy

more privacy

### LIFETIME LIMITED WARRANTY

Includes Glass Breakage & Seal Failure



Most full wood frame and composite frame entry systems using Florence Glass are ENERGY STAR® Certified. See the ENERGY STAR section of our website for energy ratings on specific styles.

612/613FLP†

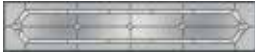

160FLP



140FLP 440FLP†



130FLP 430FLP†



350FLP



150FLP†



240FLP



243FLP



230FLP



419FLP†



400FLP†

8' DOORS



440FLP†



140FLP



430FLP†



130FLP



150FLP

† For additional door panel styles see pg. 9 (for Embarq®), pg. 13 (for Signet®), pg. 15 (for Heritage™) or pg. 17 (for Legacy™)  
 ‡ Requires an additional 6-week lead time  
 ☼ Cannot be mulled with Heritage Fiberglass doors in Certified Wind Load regions



# GEMSTONE

## DECORATIVE GLASS

Beautiful beveled glass with iced and micro-iced granite, accented with alabaster and zinc coming, gives this classic design a contemporary edge.

### CAMING FINISH



### PRIVACY RATING

1 2 3 4 5 6 7 **8** 9 10



less privacy

more privacy

### LIFETIME LIMITED WARRANTY

Includes Glass Breakage & Seal Failure



Most full wood frame and composite frame entry systems using Gemstone Glass are ENERGY STAR® Certified. See the ENERGY STAR section of our website for energy ratings on specific styles.

612/613GEM☼†



160GEM 460GEM



140GEM 440GEM†



130GEM 430GEM†



150GEM†



243GEM



240GEM



230GEM



419GEM†

8' DOORS



440GEM†



140GEM



430GEM†



130GEM



150GEM

† For additional door panel styles see pg. 9 (for Embarq®), pg. 13 (for Signet®), pg. 15 (for Heritage™) or pg. 17 (for Legacy™)

‡ Requires an additional 6-week lead time

☼ Cannot be mulled with Heritage Fiberglass doors in Certified Wind Load regions

**NEW**

MICROCUBED

BEVELED

CUBED

# GENESIS

DECORATIVE GLASS

Vertically oriented panels with microcubed and cubed privacy glass provide security and modern sophisticated style, while beveled glass inserts offer a modest glimpse of interior and exterior spaces.

## NEW ALUMINUM CAMING FINISH

Black

Silver



## PRIVACY RATING

1 2 3 4 5 6 **7** 8 9 10

less privacy

more privacy

## LIFETIME LIMITED WARRANTY

Includes Glass Breakage & Seal Failure





Most full wood frame and composite frame entry systems using Genesis Glass are ENERGY STAR® Certified. See the ENERGY STAR section of our website for energy ratings on specific styles.



† For additional door panel styles see pg. 9 (for Embarq®), pg. 13 (for Signet®), pg. 15 (for Heritage™) or pg. 17 (for Legacy™)

‡ Requires an additional 6-week lead time

⊗ Cannot be mulled with Heritage Fiberglass doors in Certified Wind Load regions

THIN REED

BEVELED

GRAY SOFTWAVE

CLEAR SOFTWAVE

# LAURENCE

DECORATIVE GLASS

Laurence features a gray softwave expressing defined classical vintage that will greet your guests with its distinguished character and prominent lines.

## CAMING FINISH

Patina



## PRIVACY RATING

1 2 3 4 5 **6** 7 8 9 10

less privacy

more privacy

## LIFETIME LIMITED WARRANTY

Includes Glass Breakage & Seal Failure



Most full wood frame and composite frame entry systems using Laurence Glass are ENERGY STAR® Certified. See the ENERGY STAR section of our website for energy ratings on specific styles.

612/613LAU†

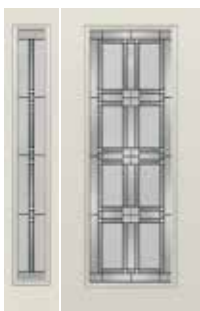
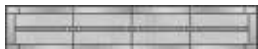

160LAU 460LAU



440LAU†

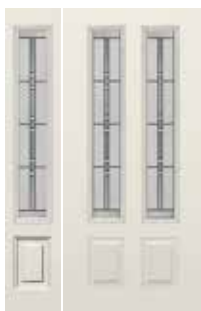

140LAU 240LAU



130LAU 430LAU†



230LAU



120LAU 420LAU-DS†



440LAU† 140LAU 430LAU† 130LAU

† For additional door panel styles see pg. 9 (for Embarq®), pg. 13 (for Signet®), pg. 15 (for Heritage™) or pg. 17 (for Legacy™)  
 ‡ Requires an additional 6-week lead time  
 ☼ Cannot be mulled with Heritage Fiberglass doors in Certified Wind Load regions

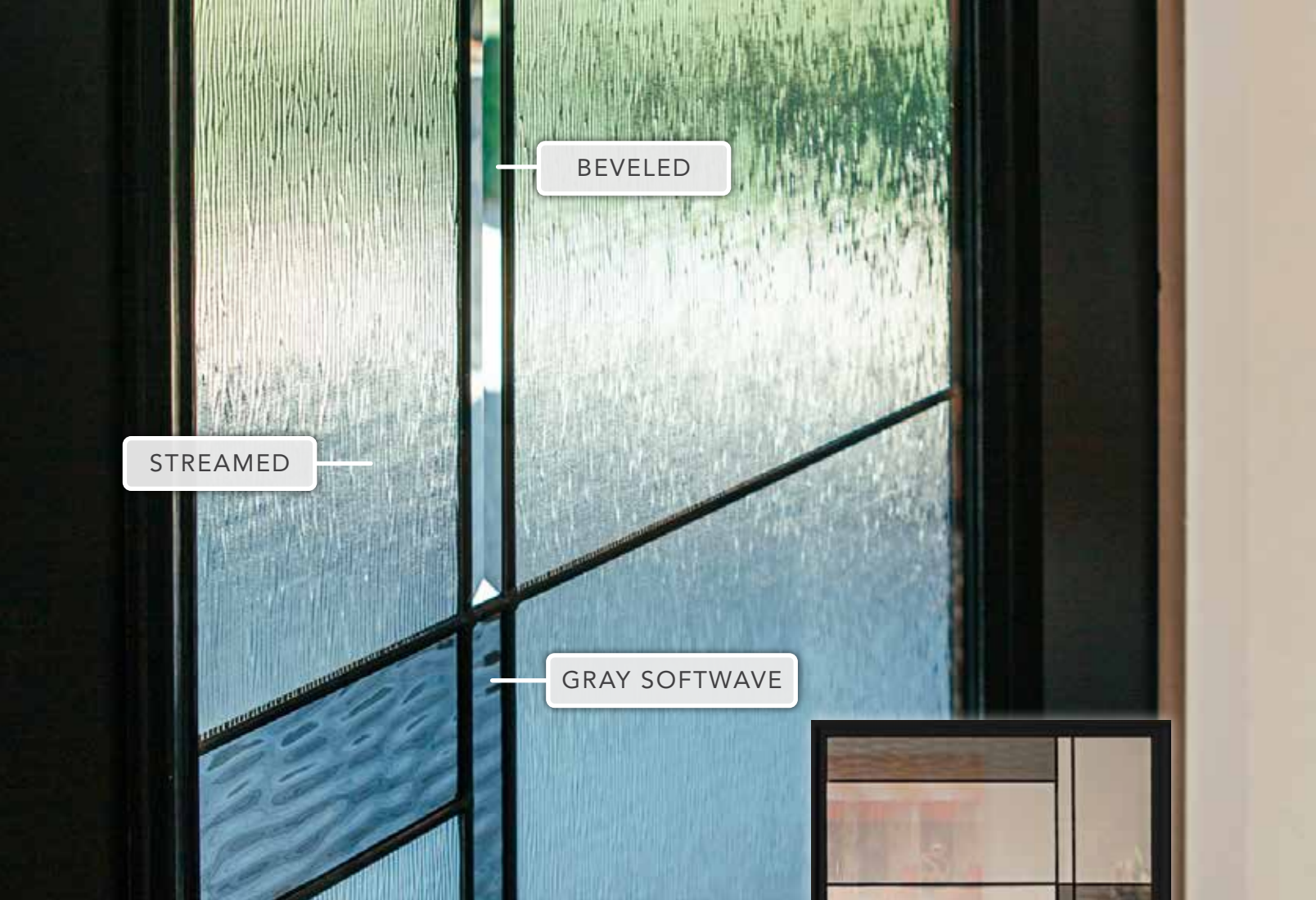

# MANHATTAN

## DECORATIVE GLASS

Manhattan features streamed glass, clear bevels and gray software, combining simplicity and modern style. Accent it with either patina or zinc coming to customize the look.

### CAMING FINISH



### PRIVACY RATING

1 2 3 4 5 6 7 **8** 9 10



less privacy

more privacy

### LIFETIME LIMITED WARRANTY

Includes Glass Breakage & Seal Failure



Most full wood frame and composite frame entry systems using Manhattan Glass are ENERGY STAR® Certified. See the ENERGY STAR section of our website for energy ratings on specific styles.

612/613MAN†

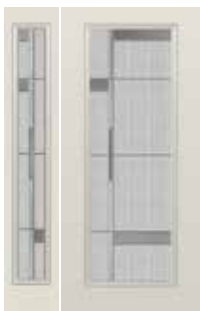

160MAN 460MAN



440MAN†



140MAN 240MAN



130MAN 430 130MAN†



230MAN



120MAN 420MAN-DST



8' DOORS

440MAN† 140MAN 430MAN† 130MAN

† For additional door panel styles see pg. 9 (for Embarq®), pg. 13 (for Signet®), pg. 15 (for Heritage™) or pg. 17 (for Legacy™)  
 ‡ Requires an additional 6-week lead time  
 ☼ Cannot be mulled with Heritage Fiberglass doors in Certified Wind Load regions



THIN REED

BEVELED

# MIRAGE

## DECORATIVE GLASS

Mirage offers effortless style, with thin reed glass all over, complemented by clear beveled glass. Zinc coming tops it off, making it a simple, modern and attractive design.

### CAMING FINISH



### PRIVACY RATING

1 2 3 4 5 6 **7** 8 9 10

less privacy                      more privacy

**LIFETIME LIMITED WARRANTY**  
Includes Glass Breakage & Seal Failure



Most full wood frame and composite frame entry systems using Mirage Glass are ENERGY STAR® Certified. See the ENERGY STAR section of our website for energy ratings on specific styles.

612/613MIR✚



† For additional door panel styles see pg. 9 (for Embarq®), pg. 13 (for Signet®), pg. 15 (for Heritage™) or pg. 17 (for Legacy™)  
 ‡ Requires an additional 6-week lead time  
 ✚ Cannot be mulled with Heritage Fiberglass doors in Certified Wind Load regions



BEVELED

MICRO GRANITE

SMALL HAMMERED

# SOMERSET

## DECORATIVE GLASS

Somerset features small hammered, micro granite and clear bevels in a simple yet elegant design with a fresh look.

### CAMING FINISH



### PRIVACY RATING

1 2 3 4 5 **6** 7 8 9 10

less privacy                      more privacy

**LIFETIME LIMITED WARRANTY**  
Includes Glass Breakage & Seal Failure





Most full wood frame and composite frame entry systems using Somerset Glass are ENERGY STAR® Certified. See the ENERGY STAR section of our website for energy ratings on specific styles.



§ Also available in 10" width. See Price List for design pattern

† Requires an additional 6-week lead time

‡ Cannot be mulled with Heritage Fiberglass doors in Certified Wind Load regions

† For additional door panel styles see pg. 9 (for Embarq®), pg. 13 (for Signet®), pg. 15 (for Heritage™) or pg. 17 (for Legacy™)



BRONZE SOFTWARE



# SYMPHONY

## DECORATIVE GLASS

Symphony features a bronze software and expresses timeless beauty and elegance at every curve. This design is sure to bring you a pleasing and melodious style.

### CAMING FINISH



### PRIVACY RATING

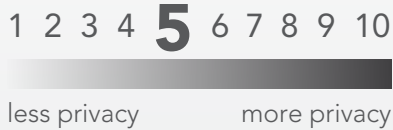

**LIFETIME LIMITED WARRANTY**  
Includes Glass Breakage & Seal Failure



Most full wood frame and composite frame entry systems using Symphony Glass are ENERGY STAR® Certified. See the ENERGY STAR section of our website for energy ratings on specific styles.



§ Also available in 10" width (which requires an additional 4-week lead time). See Price List for design pattern  
 † Requires an additional 6-week lead time

† For additional door panel styles see pg. 9 (for Embarq®), pg. 13 (for Signet®), pg. 15 (for Heritage™) or pg. 17 (for Legacy™)  
 † Cannot be mulled with Heritage Fiberglass doors in Certified Wind Load regions  
 \* In Certified Wind Load region, indicated transoms must be installed in a separate opening or use approved engineering mulls

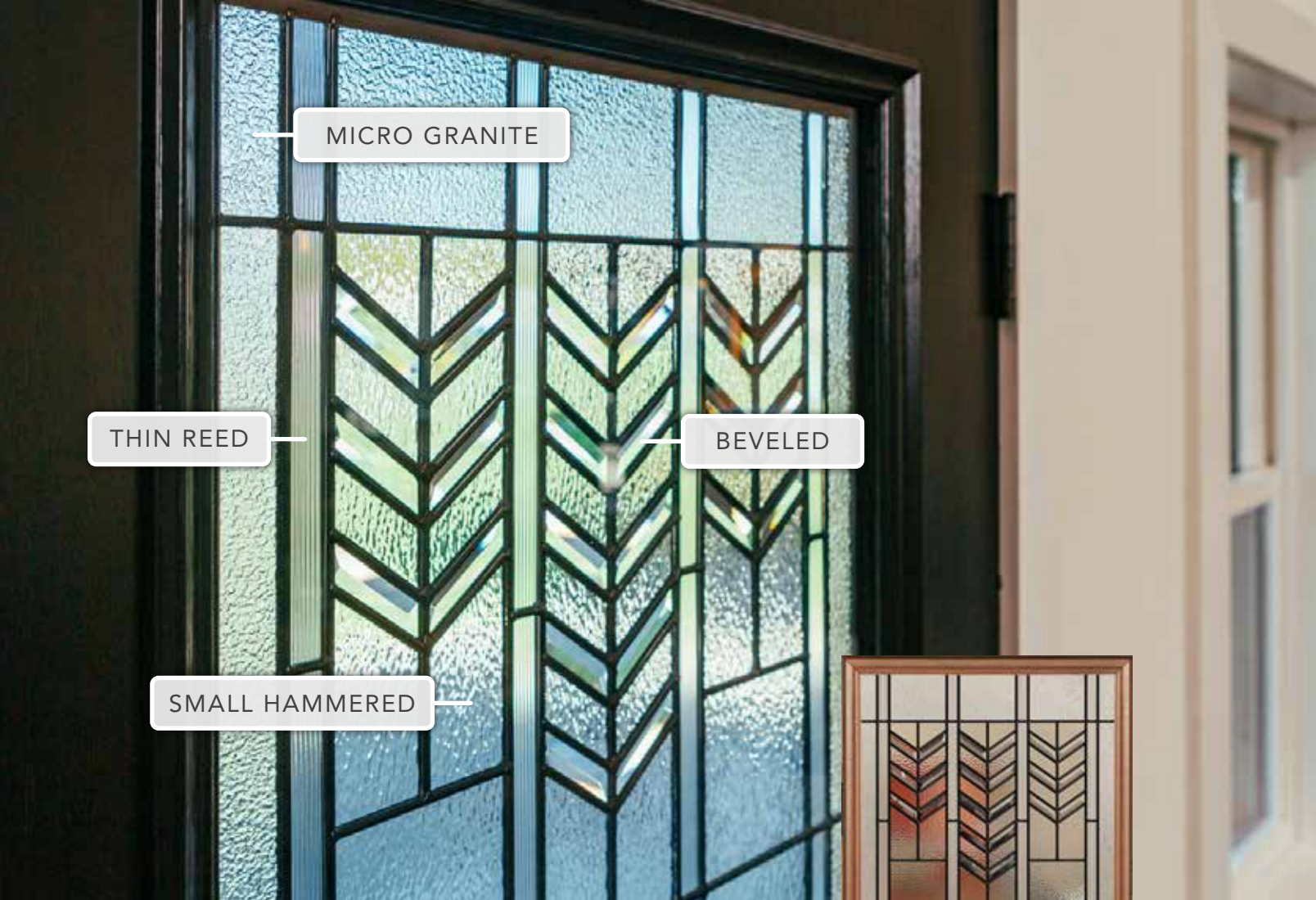

# TACOMA

## DECORATIVE GLASS

This lively design includes delicate thin reed, small hammered and micro granite glass, paired with a southwestern beveled pattern. Uniquely handsome, Tacoma offers both modern and classic elegance to your home.

### CAMING FINISH

Patina



### PRIVACY RATING

1 2 3 4 5 **6** 7 8 9 10

less privacy

more privacy

### LIFETIME LIMITED WARRANTY

Includes Glass Breakage & Seal Failure



Most full wood frame and composite frame entry systems using Tacoma Glass are ENERGY STAR® Certified. See the ENERGY STAR section of our website for energy ratings on specific styles.

612/613TAC☼†

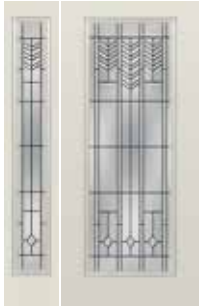

160TAC 460TAC

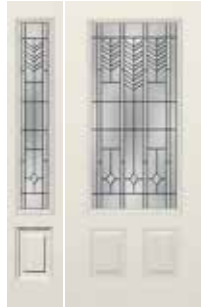

140TAC 440TAC†

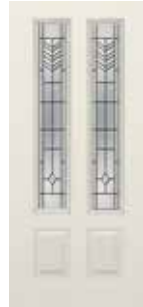

240TAC

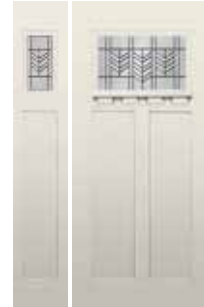

120TAC 420TAC-DS



† For additional door panel styles see pg. 9 (for Embarq®), pg. 13 (for Signet®), pg. 15 (for Heritage™) or pg. 17 (for Legacy™)

‡ Requires an additional 6-week lead time

☼ Cannot be mulled with Heritage Fiberglass doors in Certified Wind Load regions

GRANITE

BEVELED

CHINCHILLA

STREAMED

# TRANQUILITY

DECORATIVE GLASS

Tranquility features unique Chinchilla glass accented with beveled clusters and streamed glass.

## CAMING FINISH

Patina



## PRIVACY RATING

1 2 3 4 5 6 7 **8** 9 10

less privacy

more privacy

## LIFETIME LIMITED WARRANTY

Includes Glass Breakage & Seal Failure



Most full wood frame and composite frame entry systems using Tranquility Glass are ENERGY STAR® Certified. See the ENERGY STAR section of our website for energy ratings on specific styles.

612/613TRP❖

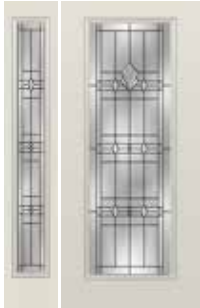

160TRP

460TRP



140TRP

440TRP†



130TRP

430TRP†



350TRP



150TRP†



243TRP



240TRP



230TRP



419TRP†



400TRP†



110TRP

8' DOORS



440TRP†

140TRZ



430TRP†

130TRP



150TRP

† For additional door panel styles see pg. 9 (for Embarq®), pg. 13 (for Signet®), pg. 15 (for Heritage™) or pg. 17 (for Legacy™)

‡ Requires an additional 6-week lead time

❖ Cannot be mulled with Heritage Fiberglass doors in Certified Wind Load regions



WROUGHT IRON

GLUECHIP (STANDARD)



# BARCELONA

WROUGHT IRON DESIGN

Barcelona features an exquisite wrought iron design with the option of choosing Gluechip (standard), Waterfall, Taffeta, Chinchilla, Obscure Pebble or clear glass.

### PRIVACY RATING

1 2 3 4 5 6 7 **8** 9 10



less privacy                      more privacy

### LIFETIME LIMITED WARRANTY

Includes Glass Breakage & Seal Failure

*Privacy rating will change based on choice of glass.*

*Barcelona is not a ProVia exclusive design.*





Most full wood frame and composite frame entry systems using Barcelona Glass are ENERGY STAR® Certified. See the ENERGY STAR section of our website for energy ratings on specific styles.



160BRC 460BRC



140BRC 440BRC†



130BRC 430BRC†



240BRC



230BRC

8' DOORS



440BRC† 140BRC



430BRC† 130BRC

† For additional door panel styles see pg. 9 (for Embarq®), pg. 13 (for Signet®), pg. 15 (for Heritage™) or pg. 17 (for Legacy™)

When you order Barcelona glass using the style code BRC, you will receive the standard Gluechip glass. To order the other Privacy Glass options shown below, use the style codes CHI, TAF, WAT or OBS after the letters BRC (e.g. 460BRC-CHI).



CHINCHILLA

PRIVACY RATING



less privacy more privacy



TAFFETA

PRIVACY RATING



less privacy more privacy

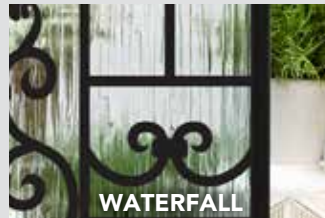

WATERFALL

PRIVACY RATING



less privacy more privacy



OBSCURE PEBBLE

PRIVACY RATING



less privacy more privacy



WROUGHT IRON

CHINCHILLA (STANDARD)



# CARMEN

WROUGHT IRON DESIGN

Carmen features a refreshing new style for an entrance way with old world style charm. Standard with Chinchilla privacy glass and also available in all privacy glass options.

### PRIVACY RATING

1 2 3 4 5 6 7 8 **9** 10



less privacy                      more privacy

**LIFETIME LIMITED WARRANTY**  
Includes Glass Breakage & Seal Failure

*Privacy rating will change based on choice of glass.*



Most full wood frame and composite frame entry systems using Carmen Glass are ENERGY STAR® Certified. See the ENERGY STAR section of our website for energy ratings on specific styles.

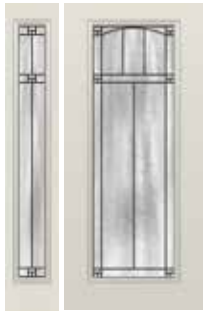

160CRM 460CRM



140CRM 440CRM†



240CRM 130CRM



430CRM† 130CRM



230CRM



120CRM 420CRM-DS

8' DOORS



440CRM† 140CRM



430CRM† 130CRM

† For additional door panel styles see pg. 9 (for Embarq®), pg. 13 (for Signet®), pg. 15 (for Heritage™) or pg. 17 (for Legacy™)

When you order Carmen glass using the style code CRM, you will receive the standard Chinchilla glass. To order the other Privacy Glass options shown below, use the style codes GLC, TAF, WAT or OBS after the letters CRM (e.g. 460CRM-GLC).



GLUECHIP

PRIVACY RATING



less privacy more privacy



TAFFETA

PRIVACY RATING



less privacy more privacy



WATERFALL

PRIVACY RATING



less privacy more privacy



OBSCURE PEBBLE

PRIVACY RATING



less privacy more privacy

# ART GLASS

A ProVia® exclusive, Art Glass offers you an opportunity to create a unique artistic statement using design and color. Your entry door glass can reflect the inspiration of your creative vision and allow you to display an original piece of art with beautiful curb appeal.



## DESIGN A **UNIQUE** PIECE OF ART GLASS

- Using **entryLINK™** or the **ProVia app**, create an entry door configuration, then select "**Art Glass**" as the glass type.
- Choose an Art Glass **design** that suits your unique style.
- Pick a complementary or contrasting **resin bead color**.
- Choose from four elegant **privacy glass options**, or **clear glass**.
- Select **colors** to fill in the design.
  - Select hues from ProVia **Standard** and **Trending** color palettes.
  - **Clear Fill** and **No Fill** may also be chosen as well as custom colors.
  - Color placement and number of colors is pre-determined and will render as you choose them. **Picture this as a color-by-number system!**

Experiment with various color combinations until you find the perfect match for your home.

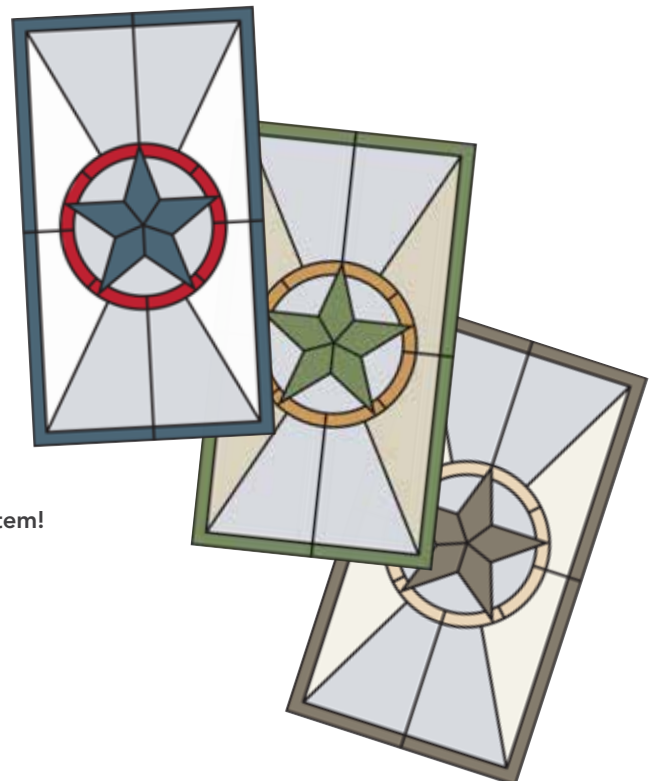

## COLOR FILL OPTIONS

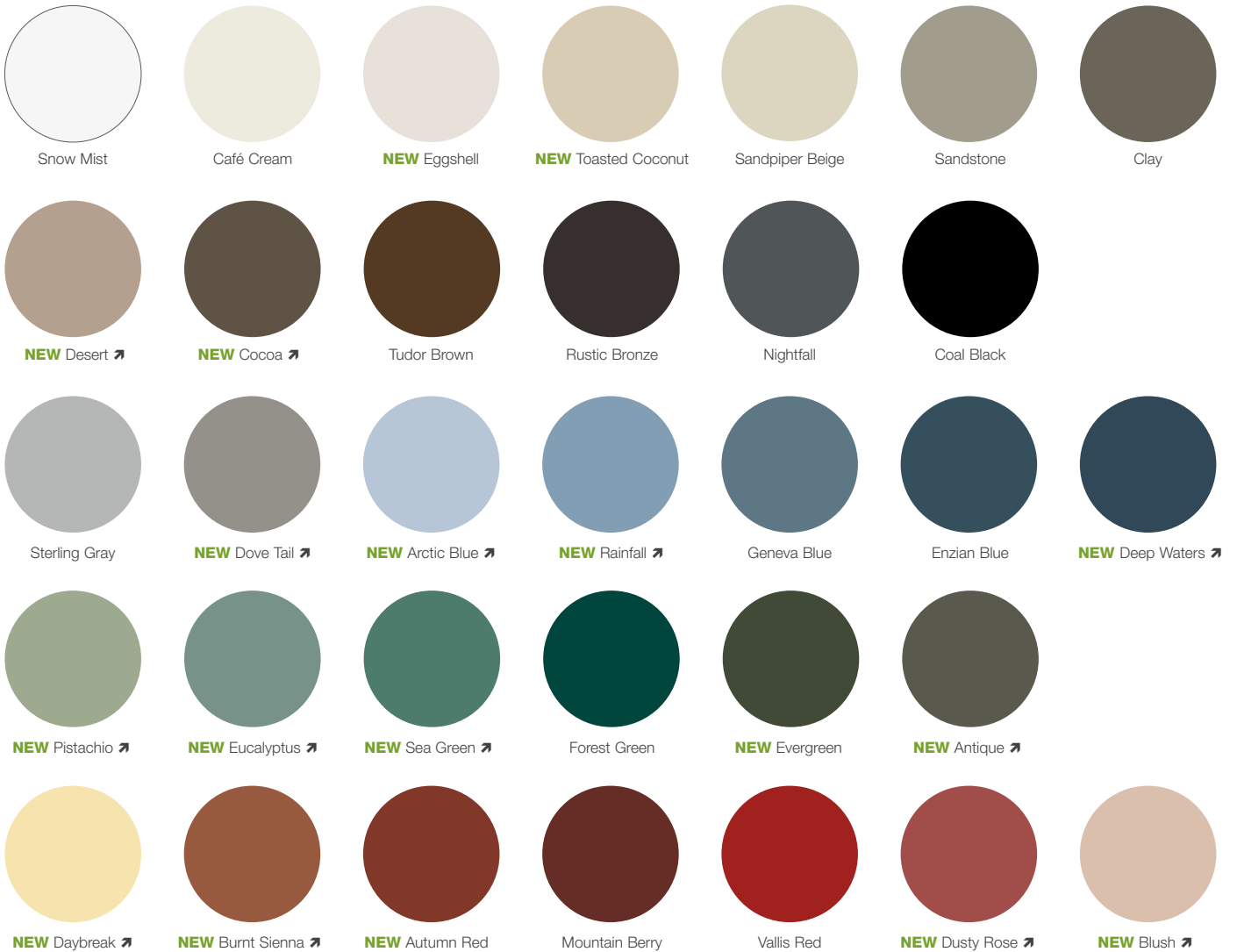

➤ Denotes Trending Color

Always refer to our color selector for accurate color representation.

Privacy glass is tempered for safety and this process may cause minuscule surface waves on the glass. Since the surface is not completely flat, the color fill may migrate toward lower points in the glass, resulting in varied saturation levels on the surface.

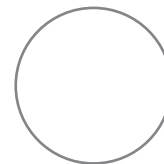

Clear Fill

### CLEAR FILL

Clear Fill imparts a degree of transparency to privacy glass. The Clear Fill option may be used on privacy glass sections of the design to allow homeowners a clearer, yet translucent view.

## RESIN BEAD COLORS



Black



Clay



Silver



Bronze



Gunmetal

AMERICANA

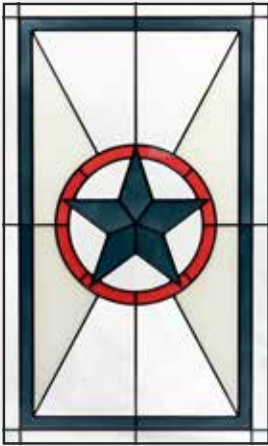

BLOSSOMS

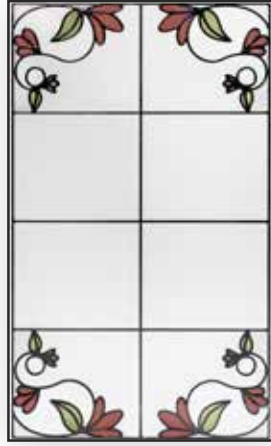

BROOKHAVEN

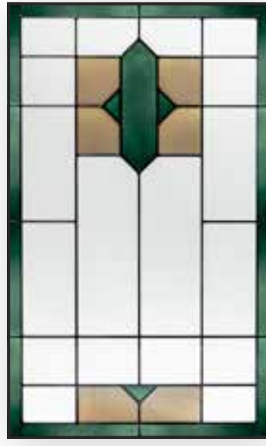

CARLISLE



ECLIPSE



ESMOND

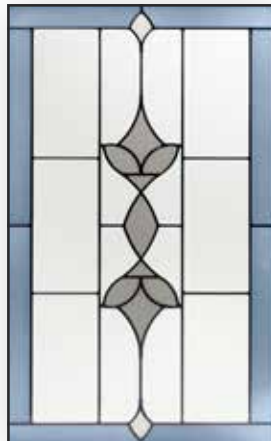

FLORENCE



GEMSTONE

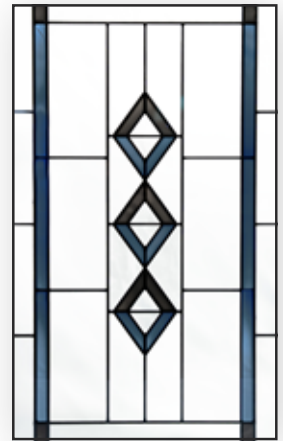

HARBOR



HAVEN

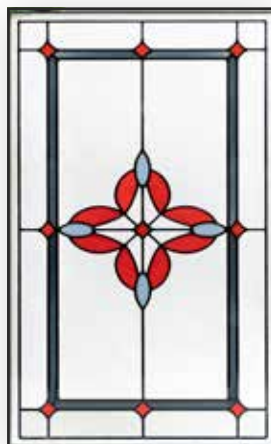

NEW IMPERIAL



LAURENCE

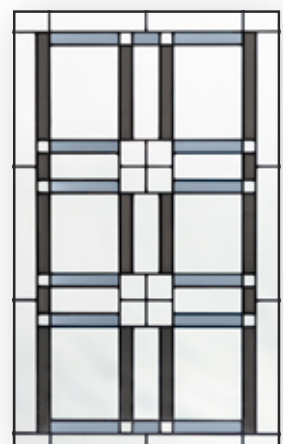

LINCOLN



MANHATTAN



NEW PALM



NEW POPPY



SOMERSET

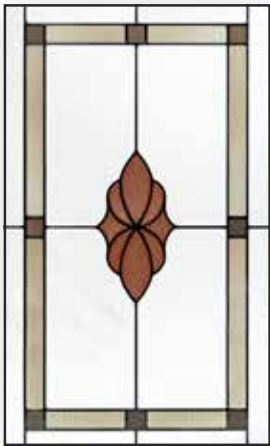

TACOMA

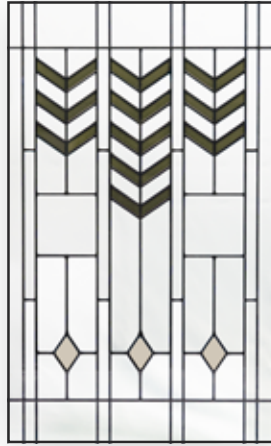

TRANQUILITY

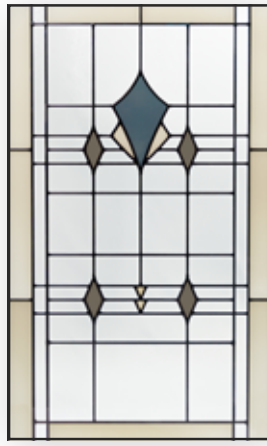

VERSA

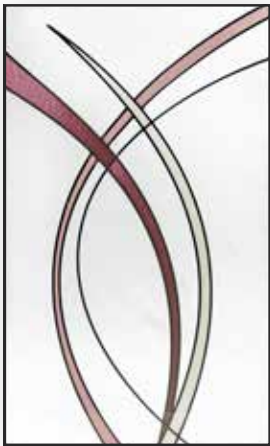

VINTAGE

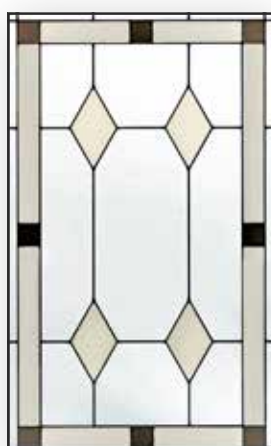

WESTIN

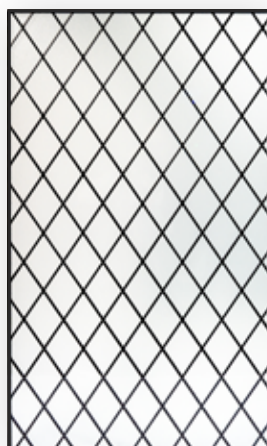

# STAIN FINISHES

---

**Applied with care, by professionals.** If you buy an entry system and finish it yourself, chances are it's the first door you've ever painted or stained. At ProVia®, stains are hand-applied by professional craftsmen, many who have been perfecting their work for years.





# EMBARQ® & SIGNET®

## 7-STEP STAIN FINISHING SYSTEM



1. **DURAFUSE™** - Proprietary P<sup>3</sup> Fusion Preparation Processes ensuring unprecedented finish durability
2. **HAND-APPLIED STAIN FINISH** formulated exclusively for Signet fiberglass doors
3. A layer of 2-part urethane, catalyst-hardened **CLEAR COAT WITH UV INHIBITORS** is applied
4. Clear coat is **OVEN-CURED** for lasting durability
5. The door is **HAND-SANDED**, preparing the surface for the second layer of clear coat
6. A second layer of 2-part urethane, catalyst-hardened **CLEAR COAT WITH UV INHIBITORS** is applied
7. The door is **OVEN-CURED** a second time, creating a long-lasting, durable finish

### Cherry & Mahogany Stains (shown on Cherry)



**NEW** Cider



Toffee

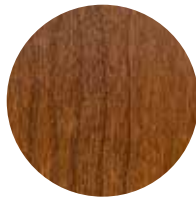

American Cherry



**NEW** Natural Bark



Nutmeg



Hazelnut



Cinnamon



Coffee Bean

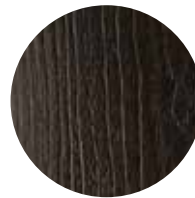

**NEW** Ebony

### Oak, Knotty Alder & Fir Stains (shown on Oak)



**NEW** Roasted Cashew



Honey Wheat



Almond

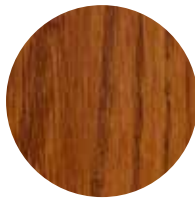

Ginger



Caramel



**NEW** English Chestnut

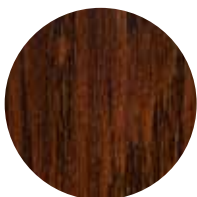

Truffle



**NEW** Aged Barrel



Espresso



**NEW** Urban Barnwood



**NEW** Ebony

# EMBARQ® & SIGNET® GLAZED FINISHES

Distinctive beauty achieved through a creative hand-applied finish giving each door a unique aged look.

## 9-STEP GLAZED FINISHING SYSTEM



1. **DURAFUSE™** - Proprietary P<sup>3</sup> Fusion Preparation Processes ensuring unprecedented finish durability
2. A 2-part urethane, catalyst-hardened **BASE COAT** (prime paint) is applied
3. Base coat is **OVEN-CURED** for lasting durability
4. **HAND-APPLIED STAIN FINISH** formulated exclusively for Signet fiberglass doors
5. A layer of 2-part urethane, catalyst-hardened **CLEAR COAT WITH UV INHIBITORS** is applied
6. Clear coat is **OVEN-CURED** for lasting durability
7. The door is **HAND-SANDED**, preparing the surface for the second layer of clear coat
8. A second layer of 2-part urethane, catalyst-hardened **CLEAR COAT WITH UV INHIBITORS** is applied
9. The door is **OVEN-CURED** a second time, creating a long-lasting, durable finish

Knotty Alder, Mahogany, Fir, Cherry & Oak Glazed Finishes *(Shown on Oak)*



**NEW** Driftwood



Windy City

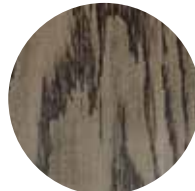

Natural Leather



Dutch Gray

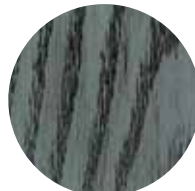

Winter Rain



**NEW** Weathered Juniper



Red Velvet

**15-YEAR FINISH WARRANTY\***  
Embarq and Signet Fiberglass

\*Warranty time period may be limited in extreme exposure applications. See warranty for details.

Glazed finishes may look slightly different depending on the skin species selected.

Always refer to our color selector for accurate color representation.

# LEGACY™ STEEL & HERITAGE™ FIBERGLASS

## LEGACY

### 6-STEP STAIN FINISHING SYSTEM



1. Steel doors are **A40 Hot-dipped Galvannealed** (300% more coating thickness than 40Z full electrolytic zinc coated steel) to resist rust inside and out
2. A 2-part urethane, catalyst-hardened **BASE COAT** (prime paint) is applied by a robotic reciprocating paint system
3. Base coat is **OVEN-CURED** for lasting durability
4. **HAND-APPLIED STAIN FINISH** is added for enhanced beauty
5. A layer of 2-part urethane, catalyst-hardened **CLEAR COAT WITH UV INHIBITORS** is applied
6. The door is **OVEN-CURED** a second time, creating a long-lasting, durable finish

## HERITAGE

### 5-STEP STAIN FINISHING SYSTEM



1. A 2-part urethane, catalyst-hardened **BASE COAT** (prime paint) is applied by a robotic reciprocating paint system
2. Base coat is **OVEN-CURED** for lasting durability
3. **HAND-APPLIED STAIN FINISH** is added for enhanced beauty
4. A layer of 2-part urethane, catalyst-hardened **CLEAR COAT WITH UV INHIBITORS** is applied
5. The door is **OVEN-CURED** a second time, creating a long-lasting, durable finish

Heritage & Legacy Stains (shown on Legacy Woodgrain Textured)



Natural Oak



Light Oak



Oak



Dark Oak



Walnut



Cherry

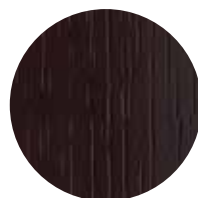

Dark Mahogany

**10-YEAR FINISH WARRANTY\***  
Heritage and Legacy Doors

\*Warranty time period may be limited in extreme exposure applications. See warranty for details.

Stain finishes may look slightly different depending on the skin species selected.

Always refer to our color selector for accurate color representation.

# PAINT FINISHES

**We do the finishing, so you don't have to.**

You wouldn't try to paint a car yourself, so why should it be any different when it comes to staining or painting your entry door?

## EMBARQ®, SIGNET®, HERITAGE™ & LEGACY™ PAINT FINISHES

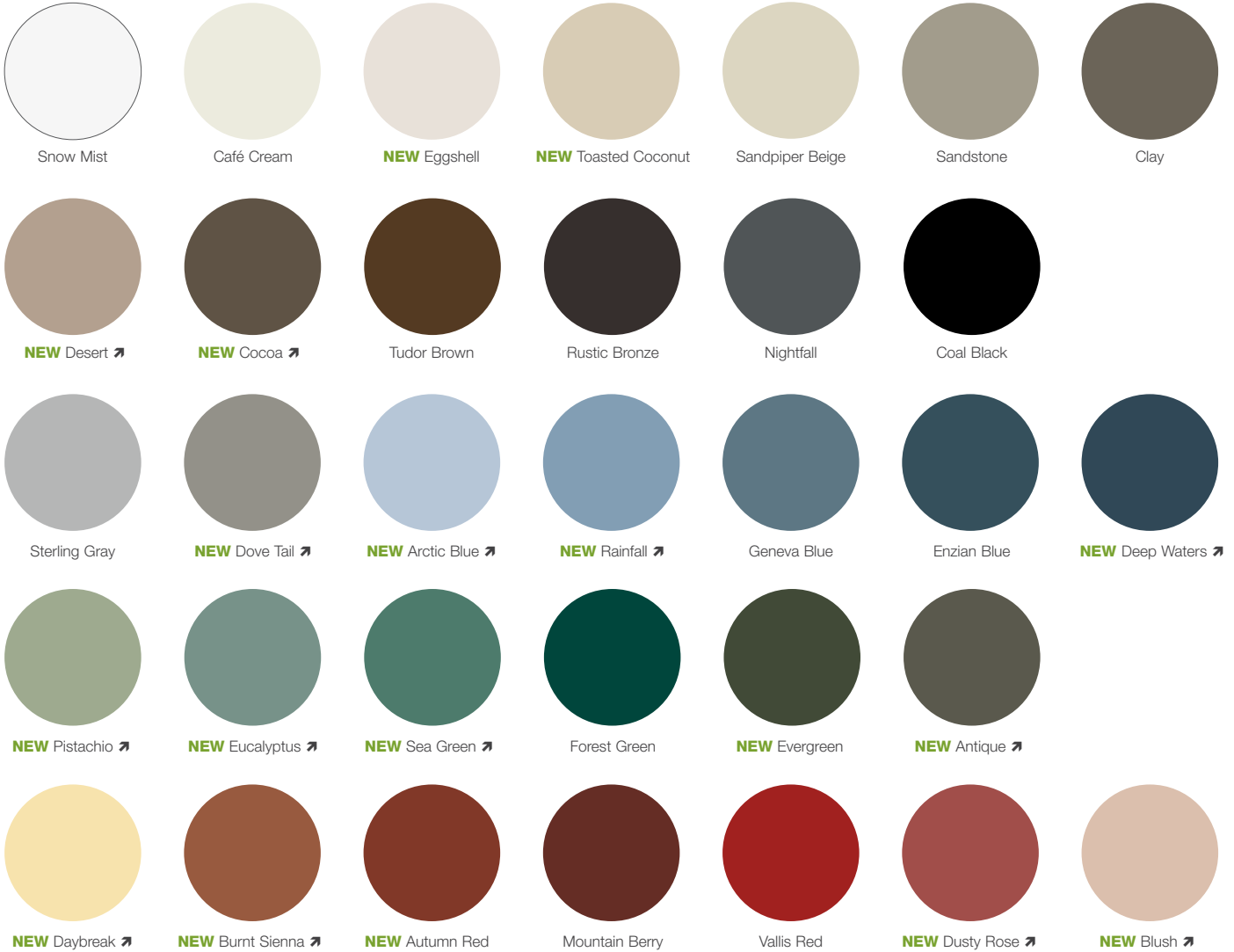

↗ Denotes Trending Color

Always refer to our color selector for accurate color representation.

### CUSTOM PAINT COLORS

Still searching for the perfect color? Custom color-matching is available on our Entry Doors.

*Custom stains also available on Signet Fiberglass Entry Doors.*

*Additional lead-time required.*



## EMBARQ AND SIGNET

### 5-STEP PAINT FINISHING SYSTEM

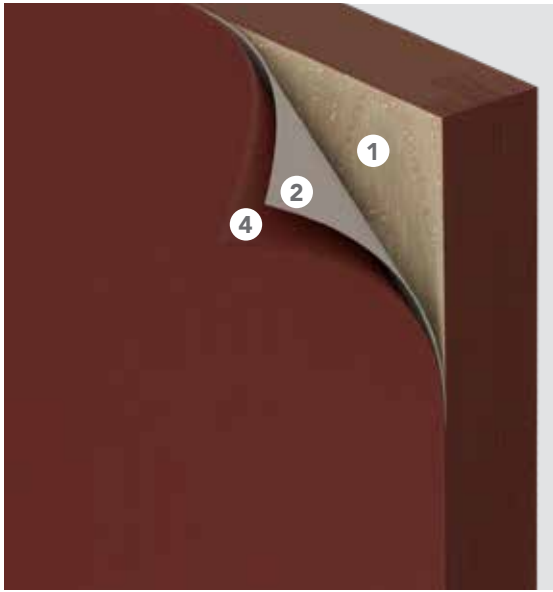

1. **DURAFUSE™** - Proprietary P<sup>3</sup> Fusion Preparation Processes ensuring unprecedented finish durability
2. A 2-part urethane, catalyst-hardened **BASE COAT** (prime paint) is applied by a robotic reciprocating paint system
3. Base coat is **OVEN-CURED** for lasting durability
4. The door is then coated with a 2-part urethane, catalyst-hardened **FINISH COAT**
5. The door is **OVEN-CURED** a second time, creating a long-lasting, durable finish

### 15-YEAR FINISH WARRANTY\*

Embarq and Signet Fiberglass

\*Warranty time period may be limited in extreme exposure applications. See warranty for details.

## LEGACY

### 5-STEP PAINT FINISHING SYSTEM

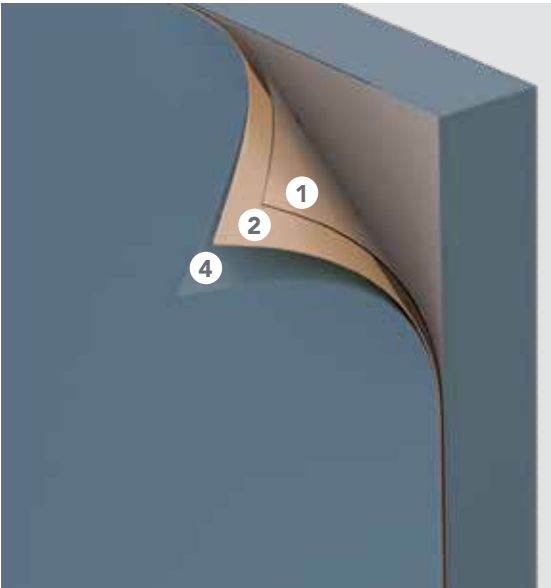

1. Steel doors are **A40 Hot-dipped Galvannealed** (300% more coating thickness than 40Z full electrolytic zinc coated steel) to resist rust inside and out
2. A 2-part urethane, catalyst-hardened **BASE COAT** (prime paint) is applied by a robotic reciprocating paint system
3. Base coat is **OVEN-CURED** for lasting durability
4. The door is then coated with a 2-part urethane, catalyst-hardened **FINISH COAT**
5. The door is **OVEN-CURED** a second time, creating a long-lasting, durable finish

## HERITAGE

### 4-STEP PAINT FINISHING SYSTEM



1. A 2-part urethane, catalyst-hardened **BASE COAT** (prime paint) is applied by a robotic reciprocating paint system
2. Base coat is **OVEN-CURED** for lasting durability
3. The door is then coated with a 2-part urethane, catalyst-hardened **FINISH COAT**
4. The door is **OVEN-CURED** a second time, creating a long-lasting, durable finish

### 10-YEAR FINISH WARRANTY\*

Heritage and Legacy Doors

\*Warranty time period may be limited in extreme exposure applications. See warranty for details.





Legacy® 460 in Eucalyptus with  
Genesis decorative glass and Emtex®  
Select Satin Nickel/Black Hardware

# HARDWARE

---

We offer a variety of designs and finishes all with their own security features, unique functionality, and advanced technology. You'll be sure to find the features and design that will ensure your front door is the perfect complement to your new entryway.



Schlage® Addison hardware in Black

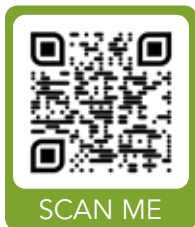

See entry door hardware styles, colors and operation videos on our website.







Emtek® Hanover Lever in Satin Brass

# PANOLOCK®+ MULTI-POINT LOCK

PanoLock® is the first and only multi-point lock that works with multiple hardware options, bringing security and performance to every entry and hinged patio door.



## A. Tapered bolt.

Unlike other locks that tend to catch, PanoLock's tapered bolts engage easily, even when the door is out of alignment.

## B. Adjustable roller strike.

Rollers lower operating force and allow the tapered bolt to gently snug the door panel against the weatherstrip.

## STRENGTH

PanoLock offers enhanced strength and security vs. standard locking systems.

## ENHANCED PERFORMANCE

Equipped with two tapered locks, PanoLock provides enhanced performance while reducing operation force.

## ULTIMATE SECURITY

PanoLock features roller strike plates equipped with extra anchor screws enhancing security.

## FLEXIBILITY

PanoLock can be used on both inswing and outswing applications.



## MULTIPLE HARDWARE OPTIONS

Thumb press, lever or knob - PanoLock+ has the ability to be paired with Schlage® and the Emtek® Urban Modern handleset. Some of the options available to you are shown below.

### EMTEK



### SCHLAGE

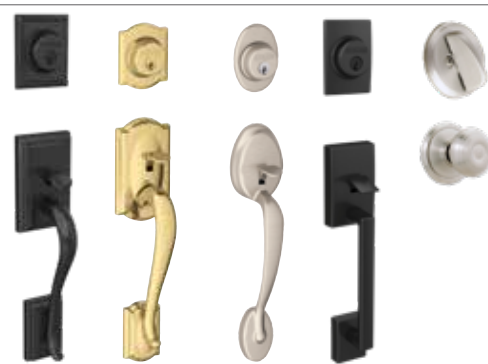

Compatible with Smart Wi-Fi Deadbolts.



1 Tapered Bolt

**SECURITY SIMPLIFIED**

PanoLock allows you to enjoy the strength and security of a multi-point lock with the ease of operation of a standard handle set. A simple rotation of the key or thumb turn activates the **top and bottom tapered bolts**.

PanoLock+ will not activate the middle latch bolt to use as a locking point. This middle latch bolt will work separately from the other two tapered bolts. It will be controlled entirely by the handleset.

PanoLock is available on standard height and 8' foot doors.

Latch Bolt

**FACEPLATE FINISHES**

Brushed Clear Anodized



Victorian Bronze



2 Tapered Bolt



# TRILENNIUM® MULTI-POINT HARDWARE

Trilennium® Multi-Point Locking System provides ultimate protection and peace of mind with the power of three full deadbolts and a solid lock design that even strengthens the door panel.

Trilennium hardware is an option for all standard size and 8' Signet® and Heritage™ fiberglass doors.

Also available on all 20-gauge Legacy™ steel doors. | NOT available on Steel L-Frames

Trilennium hardware has a 10-Year warranty on materials and workmanship.

## ECLIPSE



## PINNACLE (Not available in Black Finish)



## WESTCOTT (Not available in Bright Brass Finish)



### AVAILABLE FINISHES

Lifetime Bright Brass

Lifetime Satin Nickel

Lifetime Flat Bronze\*

Lifetime Black

\* Flat Bronze does not coordinate with Black/Bronze accessories.

Lifetime finish warranty time period is limited to five years if product is installed in a coastal region.

The Trilennium Multi-Point locking system provides more than just security. It offers homeowners better door closure and sealing than a single point lock.

- Three 1" deadbolts latch with deadbolt throw.
- Deadbolts include anti-saw hardened steel pin.
- A solid I-beam runs the full length of the lock, and increases the strength and precision of the lock.
- Latch and deadbolt release with a single downward movement.



Top and bottom latch design allows for door misalignment and  $\frac{3}{8}$ " pull-in when deadbolted.

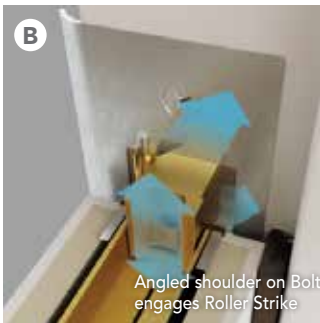

# HOPPE® MULTI-POINT HARDWARE

Hoppe Multi-Point hardware offers the additional security of four points of latching when the door is locked, and the easy operation of one point of latching when the door is unlocked.

## NEW ORLEANS CONTEMPORARY ARCH

Exterior



Interior



- Stainless Steel and other non-corrosive components.
- Anti-Back Drive prevents locking points from disengaging from the outside for added security.
- Latch Blocker on inactive systems will not allow multipoint activation until inactive system is activated.
- Lock Out Feature on interior system allows for multipoint activation from the exterior of the door by lifting handle.
- Backplate and cylinder housing are forged into one piece for improved appearance and easier installation.
- Simultaneous retraction feature enables all locking points to be retracted by pushing down on the inside handle.

## NEW ORLEANS CLASSIC ARCH

Exterior



Interior



## AVAILABLE FINISHES

Lifetime Bright Brass

Lifetime Satin Nickel

(Hoppe hardware is NOT tested for Certified Wind Load or Impact Shield regions)

Lifetime finish warranty time period is limited to five years if product is installed in a coastal region.

\*Not available on steel I-frames, patio units, and french doors

## MULTI-POINT LOCKING

(Lock body faceplate is only available in stainless steel)

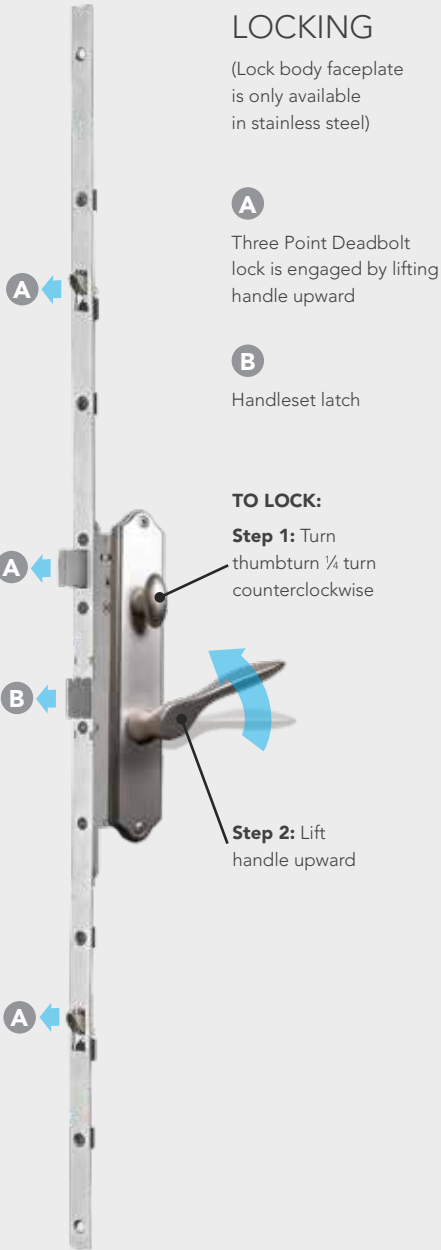

**A**

Three Point Deadbolt lock is engaged by lifting handle upward

**B**

Handle set latch

### TO LOCK:

**Step 1:** Turn thumbturn  $\frac{1}{4}$  turn counterclockwise

**Step 2:** Lift handle upward



# EMTEK® HARDWARE

Emtek's unique Interconnect Device provides the security of a locking deadbolt while providing the means for a panic-proof exit. Turning the interior knob or lever simultaneously retracts both the deadbolt and passage latches.

## EXTERIOR STYLES (Single Point Lock)

Melrose Δ



Marietta Δ



Orleans • ◇



Davos Δ



## MODERN RECTANGULAR (Two Point Lock)

Panic-proof exit not available in Modern Rectangular hardware

Round Knob Δ



Hanover Lever Δ



## INTERIOR STYLES

Egg Δ\*  
(Recommended on Melrose)



Egg Δ\*  
(Recommended on Marietta)



Cortina • ◇\*  
(Recommended on Orleans)



Stuttgart Δ  
(Only available on Davos)



Round Knob Δ



Hanover Lever Δ



Δ Not available in Bright Brass  
• Not available in Satin Brass

◇ Not available in Black  
\* Only available on Melrose, Marietta and Orleans



- Heavy-duty forged brass construction
- Durable springs
- Threaded brass tubes
- Lifetime mechanical warranty
- Lifetime anti-tarnish finish warranty

## AVAILABLE FINISHES

Lifetime Bright Brass

Lifetime Satin Brass

Lifetime Satin Nickel

Lifetime Oil Rubbed Bronze

Lifetime Black

Lifetime finish warranty time period is limited to five years if product is installed in a coastal region.



# EMTEK® HARDWARE

## EMTEK MORTISE

Emtek Mortise F13 hardware features durable brass construction and deadlocking latch bolts for worry-free security.

### EXTERIOR STYLES

Craftsman • Δ



Memphis •



Manhattan • Δ



Adelaide Δ



### INTERIOR STYLES

Hammered Lever Δ•  
(Only available on Craftsman)



Coventry Lever ◇•\*  
(Recommended on Memphis)



Square Knob • Δ\*  
(Recommended on Manhattan)



Helios Lever Δ  
(Only available on Adelaide)



Δ Not available in Bright Brass  
• Not available in Satin Brass

◇ Not available in Black  
\* Available with Memphis and Manhattan exterior styles.

- Heavy-duty forged brass construction
- Solid brass nose bolts on latches
- Lifetime mechanical warranty
- Lifetime anti-tarnish finish warranty

Forged Deadbolt with  
Anti-Saw Inserts

Anti-Pick Security Latch

Anti-Friction Trigger

EMTEK Mortise hardware is NOT tested for Certified Wind Load or Impact Shield regions.

Lifetime finish warranty time period is limited to five years if product is installed in a coastal region.

EMTEK Mortise hardware is only available for Signet Fiberglass and 20-gauge steel doors.

## AVAILABLE FINISHES

Lifetime Bright Brass

Lifetime Satin Brass

Lifetime Satin Nickel

Lifetime Oil Rubbed Bronze

Lifetime Black





Emtek Select paired with the Urban Modern handlesets allows you to add two-toned hardware on the interior to elevate and customize your entry door.

## EXTERIOR STYLES

Urban Modern  
Black



Urban Modern  
Satin Brass



Urban Modern  
Satin Nickel



Urban Modern Oil  
Rubbed Bronze



**EMTEK SELECT  
INTERIOR**  
Shown only  
for texture  
enhancement



Faceted

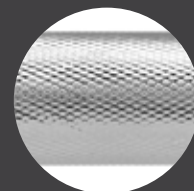

Knurled



Tribeca



Hammered

## INTERIOR STYLES

Each interior style can only be paired with its corresponding color exterior style shown directly above.

Emtek Select  
Knurled BLK



Emtek Select  
Tribeca SB



Emtek Select  
Faceted SN/BLK



Emtek Select  
Hammered ORB



Emtek Select  
Knurled BLK/SB



Emtek Select  
Tribeca SB/BLK



BLK - Black  
SB - Satin Brass  
SN - Satin Nickel  
ORB - Oil Rubbed Bronze

# DOOR PULLS

Door pulls are available with Legacy™ and Signet® Doors. Availability will be determined by door size and style.



Square Long Door Pull



Square Deadbolt



Round Long Door Pull



Modern Disc Deadbolt



48" Pull

72" Pull

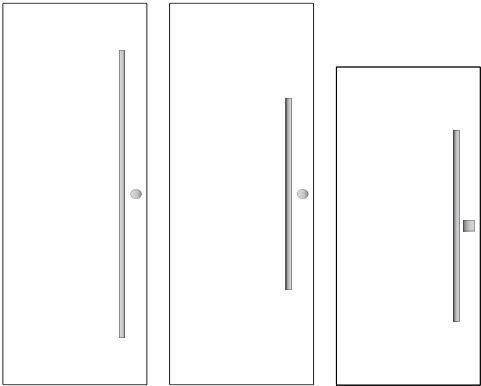
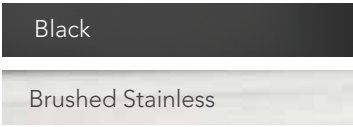

36" x 96"  
with 72" Pull

36" x 96"  
with 48" Pull

36" x 80"  
with 48" Pull



Door will be held in closed position by an adjustable roller latch system and locked by a deadbolt.

*Not currently available for French Doors*

Signet Cherry Inscribed  
001-INS3C style door with Black Square  
Door Pull with Black Square Deadbolt

# BRINKS® PUSH PULL ROTATE HARDWARE

Brinks Home Security Push Pull Rotate Knobs and Levers are the easiest, most comfortable way to open a door. With just one finger, an elbow, or your hip, you can simply push or pull your way through a door. Great if you have your hands full or free!

## EXTERIOR STYLES

Anderson with  
Celia Deadbolt\*



Harper Lever with  
Almarrion Deadbolt



Stafford Knob with  
Almarrion Deadbolt\*



## INTERIOR STYLES

Harper Lever with  
Celia Deadbolt



Harper Lever with  
Almarrion Deadbolt



Stafford Knob with  
Almarrion Deadbolt\*



*\*not available for outswing doors*

*To create the unique functionality of the hardware, the lever is designed with a special spring and may feel loose when you install it. It is operating normally.*



## AVAILABLE FINISHES

10-Year Satin Nickel

10-Year Aged Bronze

Finish warranty time period is limited to five years if product is installed in a coastal region.

## EXTERIOR / INTERIOR AVAILABLE COMBINATIONS

Exterior Handles	Interior Levers and Knobs	
	Harper Lever	Stafford Knob
Anderson	•	
Harper	•	
Stafford		•

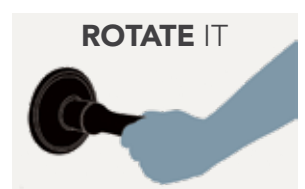

# SCHLAGE® HARDWARE

Schlage hardware offers more than just great looks, it is made to last.

## EXTERIOR STYLES

Addison\*



Camelot



Plymouth



**NEW** Century ♦



- Solid cast brass
- Maximum security deadbolt
- Nickel silver pins and keys
- Heavy duty springs
- Superior parts and design
- Lifetime mechanical warranty
- Lifetime anti-tarnish finish warranty

**NEW** Century pairs well with the Schlage Encode Plus Wi-Fi Deadbolt with Century Trim.

## INTERIOR STYLES

Georgian



Accent



Flair



Accent/Addison\*



Latitude Lever with Century Trim



## AVAILABLE FINISHES

Lifetime Bright Brass

Lifetime Satin Nickel

Lifetime Antique Brass

Lifetime Black

Lifetime finish warranty time period is limited to five years if product is installed in a coastal region.

\* Not available in Bright Brass finish  
♦ Available in Satin Nickel and Black



SCHLAGE CLASSIC  
**LOCKSETS AND DEADBOLTS**



Accent/Addison  
 Keyed Lockset\*



Accent Keyed  
 Lockset



Exterior Interior  
 Georgian Keyed  
 Lockset



Flair Keyed  
 Lockset



Latitude Lever with Century  
 Trim Keyed Lockset §



Latitude Lever with  
 Collins Trim Keyed  
 Lockset



Thumbturn  
 Deadbolts



Interior Only 1-Sided  
 Thumbturn Deadbolt ◊  
 (Only available in 20-Gauge  
 Steel or Signet Fiberglass)



Addison Trim \*



Century Trim §



Exterior Interior  
 Maximum Security  
 Double Key  
 Deadbolt ◊

SCHLAGE  
**PASSAGE LATCHES**



Accent/Addison  
 Passage Latch\*



Accent  
 Passage Latch



Latitude Lever with  
 Century Trim §



Latitude Lever with  
 Collins Trim



Flair  
 Passage Latch



Georgian  
 Passage Latch

**SCHLAGE CLASSIC  
 HARDWARE FINISHES**

Lifetime Bright Brass

Lifetime Satin Nickel

Lifetime Antique Brass

Lifetime Black

Lifetime finish warranty time period is limited to five years if product is installed in a coastal region.

◊ Interior Only 1-Sided Thumbturn Deadbolts on any door which is used for egress may be a safety hazard in times of emergency double key deadbolts on any door which is used for egress are a safety hazard in times of emergency.

\* Not available in Bright Brass finish

§ Only available in Satin Nickel and Black finish

# SCHLAGE® HARDWARE

## ELECTRONIC KEYPADS

### SCHLAGE ENCODE PLUS™ SMART WIFI DEADBOLT

**Smart. Simple. Secure.**

Schlage's next generation smart lock offers consumers unparalleled flexibility with new smart home capabilities that provide even greater convenience and security for home access control.



- Offers iOS and Android compatibility
- Remotely (un)lock, check status, manage 100 pin codes (24/7, schedules, temporary), receive notifications, see lock history
- Voice control with Alexa or Google Assistant



- First major North American lock brand to support new home keys for iPhone and Apple Watch feature (coming with iOS 15 release, no Apple hub required to use home keys)
- HomeKit experience: (Un)Lock from phone/watch app, status, 24/7 pin codes\*, Siri voice control, notifications
- Remote connectivity and automations through HomeKit require an Apple home hub

Camelot



Century



### AVAILABLE FINISHES

Lifetime Satin Nickel

Lifetime Black

## ELECTRONIC DEADBOLT

### ELECTRONIC KEYPAD DEADBOLT

### ACCENT LEVER ELECTRONIC LOCKSET



Electronic locksets and deadbolts utilize Schlage's Innovative keyless access. It's convenient and is customizable to fit your security needs.

- Deadbolt is available with any Schlage entry hardware
- 9-volt battery included
- Lighted keypad
- Up to 19 user codes
- Easy to add or delete codes
- Lifetime Mechanical and 3-Year Electronics Warranty

### AVAILABLE FINISHES

Lifetime Bright Brass

Lifetime Antique Brass

Lifetime Satin Nickel

Lifetime Black

Lifetime finish warranty time period is limited to five years if product is installed in a coastal region.

# HARDWARE ACCESSORIES

Sometimes the smallest things make the biggest difference. Our accessories add a lot to the look of your entry system.



Mail Slot or Magazine Slot\*  
 NOT tested for Certified Wind Load or Impact Shield regions  
 Doors with Mail Slot or Magazine Slot are not ENERGY STAR® certified



7/8" Peepsite\*\*



Kick Plate

## Decorative Hinges

Also available in Satin Nickel & Oil Rubbed Bronze (Inswing only)

NOT tested for Impact Shield regions.



Steeple



Ball

## FINISHES

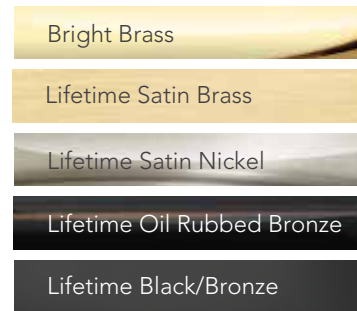

## ACCESSORIES FINISH AVAILABILITY 5-Year Mechanical Warranty

Accessories	Lifetime Finish					5-Year Finish		No Finish Warranty	Impact Shield 5-Year Finish
	Bright Brass	Satin Brass	Satin Nickel	Bronze	Black	Bright Brass	Antique Brass	Oil Rubbed Bronze	Bright Brass, Satin Nickel, Black/Bronze and Satin Brass
Colonial Door Knocker	•		•	•	•			•	• (N/A Black/Bronze)
Classic Door Knocker/Viewer	•	•	•	•	•	•	•		•
Classic Door Knocker	•	•	•	•		•	•		•
Magazine Slot*	•	•	•	•		•	•		
Mail Slot*	•	•	•	•		•	•		
Kick Plate	•	•	•	•		•	•		•

\* Mail slot and magazine slot are not available on 003C, 006C, 008P, 009, 420-DS, 420-2P, 420-3P, 110, 243, 440, 240, 449, 460, & 350 door styles. Additionally, magazine slots are also not available on 002C-449 & 003 door styles.

\*\* Peepsite available in Bright Brass, Chrome (recommended for use with Satin Nickel hardware finish) and Aged/Antique (recommended for use with Black, Oil Rubbed Bronze or Antique Brass hardware finish) with 5-year finish warranty.

# ENTRY DOOR OPTIONS

The Hinge Straps, Clavos and Speakeasy are options that can give your entryway an old world look. Combine these options with our Signet® Knotty Alder Series to achieve a rustic or antique style. Hinge Straps, Clavos and Speakeasy are constructed of durable flat black aluminum.



002CP-449 Signet Cherry Fiberglass in Natural Leather Glaze with Oil Rubbed Bronze Emtek Davos Handle | 160 Style Signet Cherry sidelites with Waterfall Privacy Glass.

## HINGE STRAPS Available on all door styles shown on opposite page

 Available as an Impact Shield product.



## CLAVOS Available only on door styles shown with planks on opposite page (002CP-449, 002CP-437, 8' 002CP-449 and 8' 002CP-437)

 Available as an Impact Shield product.



**SPEAKEASY** Available on all door styles shown below except for 8' 002C-437 and 8' 002CP-437

NOT tested for Certified Wind Load or Impact Shield regions. (Doors with Speakeasy are not ENERGY STAR® certified.)

ProVia® does not recommend entry doors with Speakeasy applications in the Northern climate zone. We also recognize some of the North-Central climate zone areas are not suitable for this application as well. We recommend this application to be used only in the South-Central and Southern climate zones. Speakeasy applications carry a 5-year limited warranty. See price book for more details.



Exterior



Interior

**IRON DOOR**

Not available on Embarq



Exterior



Interior

**SEA SPRAY GLASS DOOR**

(single pane)

Not available on Embarq

**FAUX SPEAKEASY**

Enjoy the decorative look of a speakeasy without impeding the energy efficiency of the entry door. Available on all door styles shown below.



**SIGNET® & EMBARQ® FIBERGLASS DOOR STYLES**

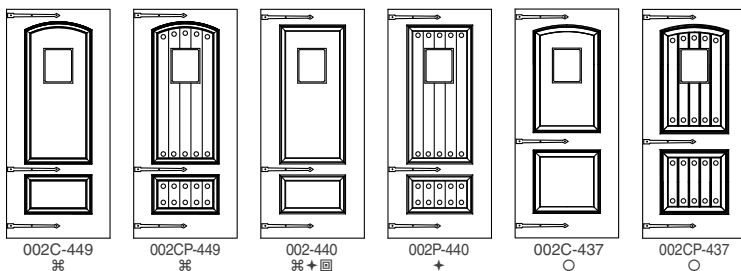

- ⌘ Signet/Embarq Cherry
- + Signet/Embarq Oak
- Signet/Embarq Knotty Alder
- Signet Smooth

Embarq doors can only use the Faux Speakeasy

**8' SIGNET FIBERGLASS DOORS**



# ENTRY DOOR OPTIONS



## RANGER® PET DOOR

Engineered from the best raw materials for a rugged, long-lasting door.

- **Cellular PVC Frame** – Strong, weatherproof, and mold-resistant, and 3,000X more insulating than metal frames.
- **Rugged Flap System** – The insulated flap system is made from premium materials for maximum energy-efficiency, pet safety, and durability. The flap has an insulating SBR rubber core, protected with marine-grade canvas on each side.
- **Locking Security Panel** – All door-mounted RANGER dog doors include a locking security panel.
- **DoubleMag™ Technology** for an airtight seal that keeps extreme weather outside.

### COLORS

- Clear flap with white interior/exterior frame and a white locking panel on the interior.
- Grey flap with black interior/exterior frame and a black locking panel on the interior.

See [entryLink](#) for details

**Small:** 6" x 10" opening for pets up to 20 lbs.

**Medium:** 9" x 13" opening for pets up to 40 lbs.

**Large:** 11" x 17" opening for pets up to 100 lbs.

**X-Large:** 16" x 23" opening for pets up to 220 lbs.



White Locking Security Panel as viewed from interior of your home.



## FREEDOM® PET DOOR

- Solid aluminum construction
- Slide-in panel to control access inside and outside the home
- Soft single flap for tight weather seal
- Antique White mitered aluminum frame
- Also available on storm doors.

**Medium:** 8¼" x 12¼" opening for pets up to 40 lbs.

**Large:** 10¼" x 16¼" opening for pets up to 100 lbs.

**X-Large:** 13¾" x 23¾" opening for pets up to 220 lbs.

### BOTH PET DOOR OFFERINGS

(NOT available in [Certified Wind Load](#) or [Impact Shield](#) regions)  
(Doors with Pet Door are not ENERGY STAR® certified)

Factory Installed - Available on Flush Doors Only



## CASING

Put the finishing touch on the inside of your entryway with our beautiful interior casing. Available in Cherry, Mahogany, Fir, Oak or Poplar wood.



2 1/2" Modern ▲



2 1/2" Colonial ▲



3 1/2" Colonial ▲



2 1/2" Flat\*



3 1/2" Flat\*

Available for any door configuration including transoms.

Signet® stains are available on Cherry, Mahogany, Oak or Fir casing, and Heritage™ and Legacy™ stains are available on Oak or Poplar casing. Paint and glazed finishes are available on Poplar casing.

### Custom Casing

Don't see a casing style you need? We have a custom casing program that can meet your needs. Contact your dealer for additional information on our Custom Casing program.

\* Only available in Fir and Poplar

▲ NOT available in Fir



3" Wide Brickmold  
Choose from our standard 2" brickmold or our wider 3" brickmold.

## ALUMINUM PRE-FIT CLADDING

Cladding is worth the small investment. You can add cladding to any FrameSaver® or PermaTech™ Composite Frame.

- Protective
- Maintenance-free
- Stays beautiful
- Factory applied

### TEXTURED CLADDING COLORS

Snow Mist	Café Cream	Sandpiper Beige
Sandstone	Clay	Sterling Gray
Enzian Blue	Geneva Blue	Forest Green
Vallis Red	Mountain Berry	Tudor Brown
Oak	Cherry	Rustic Bronze
Coal Black	Nightfall	

### NEW

Eggshell	Toasted Coconut
Autumn Red	Evergreen

### TUFTEX™ SMOOTH CLADDING COLORS

Aluminum trim coil with mar-resistant smooth finish.

Snow Mist	Sandpiper Beige	Sandstone◇	Classic Bronze*	NEW Coal Black
-----------	-----------------	------------	-----------------	----------------

◇ Smooth Sandstone cladding is a close match, but not an exact match to Sandstone paint color.

\* Smooth Classic Bronze cladding does not match Rustic Bronze cladding color or Rustic Bronze paint color.

# HINGED PATIO DOORS

Hinged Patio Doors are swinging patio door systems available in 2 or 3-lite units and constructed of the same solid quality Signet® and Heritage™ Fiberglass, and Legacy™ Woodgrain Textured or Smooth Steel doors as our entry door units.

Hinged Patio Doors with Heritage Fiberglass are NOT available in Certified Wind Load regions.



460 Style Smooth Legacy Steel Hinged Patio Door painted Rustic Bronze featuring White Internal Blinds and a Black Schlage Encode Plus™ Electronic Deadbolt.



## PATIO DOOR STANDARD FEATURES



A keyed **Schlage® Flair** handleset with a **Maximum Security Thumbturn deadbolt** is included. Choose from Bright Brass, Antique Brass, Satin Nickel or Black finish.



The lock area is reinforced with a **20-gauge steel security plate** for added strength.



**Spring-loaded latch system** automatically engages upon closing. Latch also includes interior locking feature. **BetterVue® fiberglass screen mesh** is standard. Heavy-duty fiberglass, aluminum or SeeVue® stainless steel screen is optional.



Suspended by ball bearing rollers this **top-hung heavy-duty aluminum screen frame** reduces binding, creating effortless operation. Screen frames are available in all standard paint colors.



**Z-AC™ Threshold** with an auto-adjusting riser. Available in Mill or Anodized Bronze Finish.

## OPTIONS

**Custom Widths and Heights** - Need a little more height or a little less width? We are pleased to offer customized patio door widths and heights in 1/8" increments.

**Door Swing** - (Doors viewed from above. Inswing only.)

**Finishes** - Patio doors are available in all finishes shown on pages 37-42.

\* Optional Aluminum Frame Cladding will increase brickmold to brickmold width by 1/4" and height by 1/8". Not all sizes available in all door types.

## DOOR SWING

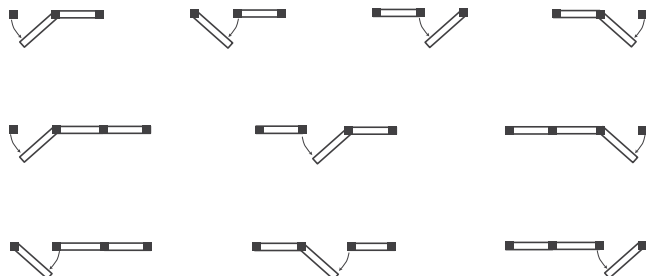





002CP-449 Signet doors in Caramel  
Barcelona Decorative Glass sidelites  
with Emtek Mortise Craftsman hardware  
in Oil Rubbed Bronze

# STORM DOORS

Every storm door is individually customized to the highest standards in the residential market for homeowners who appreciate impeccable, uncompromising quality. Please see ProVia® Storm Door brochure or scan QR code for all options.



SCAN ME



Coal Black Spectrum 291SH Full View storm door with Black Sierra Mortise Handleset



Smooth function is essential. That's why we include a **quality door closer** in every storm door package. Varies by model.

Our air release system features a continuous closing action without the delayed rebound action of previous generation closers.



**Extruded aluminum frame** adds beauty to your door by virtue of the rounded cove molding along the glass edge of the extrusion.



All our storm doors are constructed with **tempered safety glass**.

Non-operable sashes are secured by our **color matched polycarbonate clips** or an **internal sash lock system**. Varies by model.

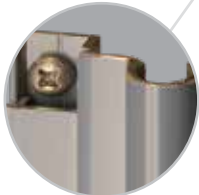

You'll appreciate the finished look of our **color matched aluminum installation screw covers**.

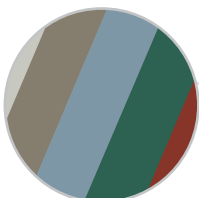

**Durable, oven-baked polyester finishes** are backed by a Lifetime Warranty for lasting beauty and low maintenance.

Each door features **quality hardware** that adds beauty and functionality to your new storm door. Varies by model.



**Corrosion-proof corner gussets** enhance the structural integrity of the door.



Our **bottom expander with sweep** allows for a beautiful custom-fit to any entry. Varies by model.

# STORM DOOR DETAILS

The details are the small things that set our storm doors apart from the competition. A lot of small things add up to a big difference.

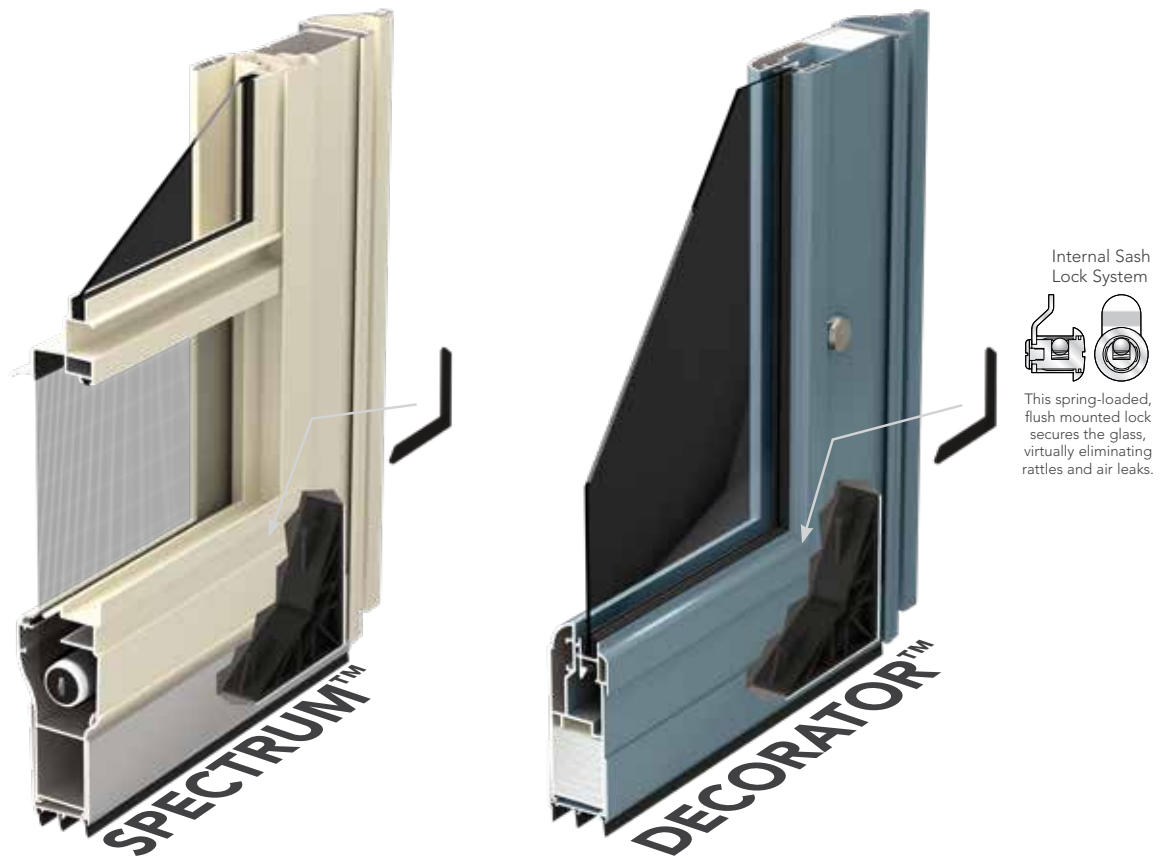

Spectrum Decorator Deluxe DuraGuard Superview

## Construction

InVent™ Retractable Screen System	✓				
Outside corners are secured to corrosion-proof gussets, for structural integrity	✓	✓	✓	✓	✓
Color matched aluminum installation screw covers enhance the appearance of your door	✓	✓	✓	✓	✓
The bottom sweep eliminates drafts	Triple	Triple	Triple	Triple	Triple
The sculptured frame adds durability	1¼" x 4¾"	1¼" x 4"	1¼" x 3 ⅝"	1¼" x 3 ⅝"	1¼" x 2 ⅝"
Multi-hollow construction provides greater strength and security than standard storm doors	✓	✓	✓	✓	
The reinforced aluminum kick panel adds durability	✓		✓	✓	
The aluminum kick panel resists rust and adds strength	✓		✓	✓	✓

## TOP STORM DOOR FEATURES

- Custom sizing availability
- Can be keyed to match entry door
- Matched to painted entry door color
- Optional double mortise hardware
- Custom door configuration ability



Spectrum    Decorator    Deluxe    DuraGuard    Superview

Construction	Spectrum	Decorator	Deluxe	DuraGuard	Superview
Corner keys provide added support to the inside of the door frame	✓	✓	✓	✓	
Aluminum wall up to 20% thicker than industry standard	✓	✓	✓	✓	
The .023 gauge stainless steel screen offers extra security and protection (12 x 12 mesh)				✓	
Non-operable sash/screen secured by internal lock system or color matched polycarbonate clips		Internal Locks	Clips	Clips	Clips
Standard insulated frame core to help reduce air movement	Optional	✓	Optional	Optional	
Screen included	✓	Optional	✓	✓	✓
Available in all standard and trending paint colors	✓	✓	✓	✓	
Clear tempered safety glass	✓	✓	✓	✓	✓

# DISCOVER MORE

## WEBSITE

ProVia.com makes it easy to explore and compare numerous door, window, siding, stone or roofing options in a straightforward, interactive way. Configure a door or window, visualize products on your home, explore color palettes, and learn about different architectural styles—all from our innovative Design Center. Save your favorite products, colors, photos or ideas throughout the site into your own ProVia portfolio for reference any time and share them across your favorite social media platforms. ▶

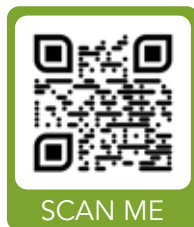

## VISUALIZER

Let your imagination run free with this exterior home design tool. Select from a library of existing home styles or upload a photo of your own home.

In a few easy steps, update your siding color, add stone or metal roofing, configure windows, or create a one-of-a-kind entry door system.

Looking for professionally inspired color and product palettes? Apply one of our pre-selected Designer Collections to create a curb-appealing look. ▾

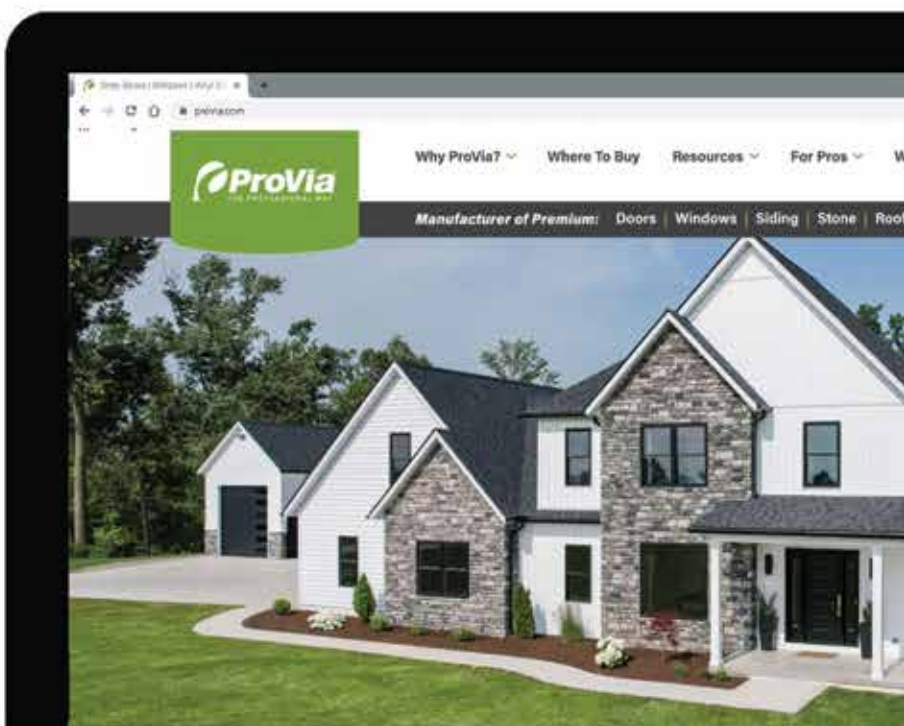





## APP

Use the ProVia app to configure doors and windows or select from an extensive collection of vinyl siding, manufactured stone and metal roofing styles.

### FEATURES

- Door and Window Configuration
- Vinyl Siding Profiles, Colors and Accessory Accents
- Manufactured Stone Styles, Color Palettes and Grout Options
- Metal Roofing Profiles, Trims and Colors
- Videos, Photo Galleries and Catalogs
- ProVia Dealer Locator



## SOCIAL MEDIA

We love seeing how you apply our products to your ▾ home. Please share your photos with us.

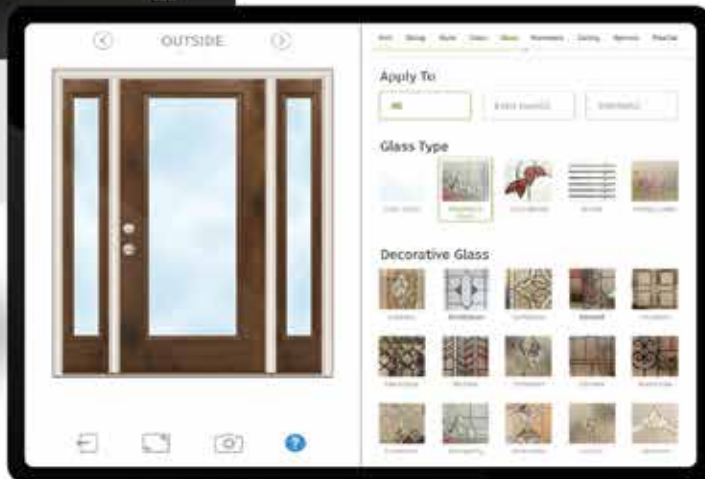

**ELEVATE YOUR  
ENTRYWAY WITH  
A PROVIA® DOOR.**



Legacy 420-4P French Entry Door stained Dark Oak with Black Schlage Addison Grip Handle





“To serve, by caring for details in ways others won’t.” It’s not just our mission, but a way of letting our light shine every day at ProVia®. We continually strive to put these words into action by providing unmatched quality and service. The P-icon symbolizes each employee’s commitment to devoting the utmost care, pride and quality into each building product we manufacture...it’s The Professional Way.



At ProVia, we manufacture energy efficient products and exercise corporate environmental stewardship by recycling, reducing pollution emissions and much more. In fact, our company has received repeated awards from the Environmental Protection Agency such as Partner of the Year - Sustained Excellence for Door and Window Manufacturing.



DOORS | WINDOWS  
SIDING | STONE | ROOFING  
[provia.com](http://provia.com)

© 2024 ProVia  
P-MK-03005-24 | 10/23

Distributed by: